

Product Overview

Electrical safety for mobile power generators

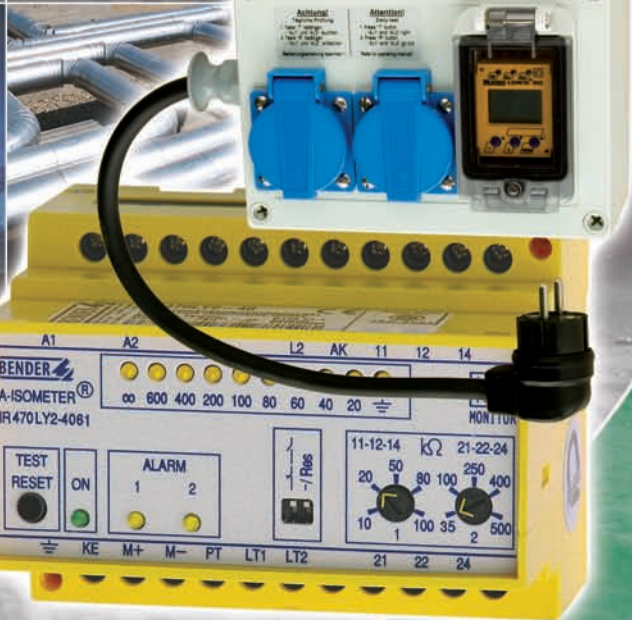

Electrical safety when using mobile power generators



Mobile power generators are now used as power supply in many applications, e.g.

- In water ditches, and cable and pipe trenches
- In disaster control
- In firefighting
- For supplying emergency power to loads that are disconnected from the mains
- In agricultural

They are used for supplying power to

- Machines
- Life-saving equipment
- Lighting systems
- Welding equipment
- Pumps
- Measuring equipment

to name but a few examples

Electrical safety for every situation

Whatever the application, the issue of finding the right form of protection (i.e. one that is safe and easy to use) will always need to be addressed. In spite of the obvious urgency and the fact that it is only an interim measure, it is vital to ensure that people, devices and systems are all protected against the potential electrical hazards.

Because we are used to using electrical equipment on a daily basis, we tend to forget how much time and effort electrical technicians have to invest both before a system is installed and while it is actually in use to ensure that it is properly protected. The following all have to be taken care of:

- Earthing systems must be installed
- Earth contact resistance values have to be controlled and observed
- The function of any protective measure must be tested, e.g. RCD (residual current device)

Electrical safety – Is it a problem?

These measures do not pose a problem in the context of the permanently installed supply system. But what is the situation like in the following workplace scenarios?

- Cases where no earthing system has been “constructed”
- Cases where it is very unlikely that the substrate/ environment would permit the construction of an earthing system (stones, rubble, rock, asphalt, etc. would have to be penetrated).
- Where time is of the essence and there is not enough time to measure and check the protective measure
- Where there is no electrical technician available

Reeling off the list of problems is easy and any user of mobile power generators will no doubt be familiar with them all.

Standards applicable to the electrical safety of mobile power generators

DIN VDE 0100-551 (VDE 0100 Part 551): 1997-08

"Electrical installations of buildings; Part 5: Selection and erection of electrical equipment; Chapter 55: Other equipment; Section 551: Low-voltage generating sets (IEC 60364-5-551: 1994) German version HD 384.5.551 S1: 1997".

IEC 60364-5-551:1994

Electrical installations of buildings – Part 5: Selection and erection of electrical equipment – Chapter 55: Other equipment – Section 551: Low-voltage generating sets.

DIN VDE 0100-410 (VDE 0100 Part 410):2007-06

"Erection of power installations with nominal voltages up to 1000 V – Part 4: Protection for safety; Chapter 41: Protection against electric shock (IEC 60354-4-41: 2005, modified), German version HD 384.4.41 S2: 1996".

Technical bulletin GW308 August 2000

Mobile standby generators for pipeline construction sites; equipment and operation, DVGW Deutsche Vereinigung des Gas- und Wasserfaches e.V. (The German Technical and Scientific Association for Gas and Water), Bonn

DIN 14686, Edition: 2003-10

Switch cabinets for fixed generators > 12 kVA in fire-brigade vehicles

DIN 14687, Edition:2007-02

Firefighting equipment – Permanently installed generators (generating sets) less than 12 kVA for use in firefighting vehicles

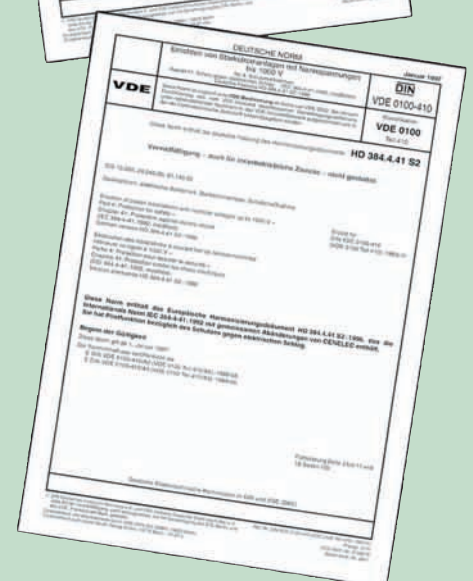
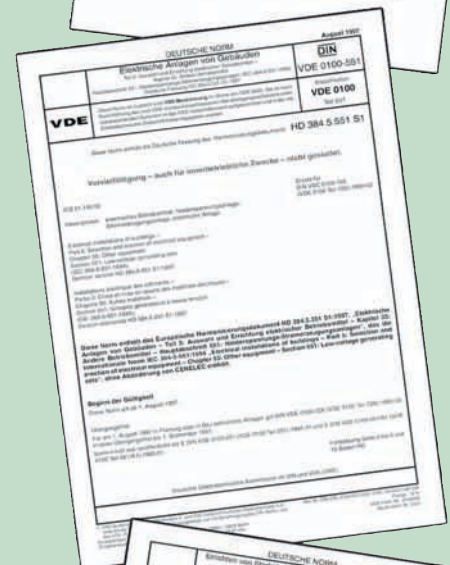

Protective measures for mobile power generators

Select a protective measure in accordance with DIN VDE 0100-551 (VDE 0100 Part 551):1997-08 that suits your practical needs

DIN VDE 0100-551 (VDE 0100 Part 551):1997-08 stipulates that the following form of protection must be used (Section 551.4.4.2):

"In TN, TT and IT systems, an RCD with a maximum rated residual current of 30 mA must be installed to ensure automatic disconnection in accordance with section 413.1 of IEC 60364-4-41."

Generally speaking, this means using the TN system, an RCD (residual current device) and an earth rod and having the installation tested by an electrical technician prior to each use, which can hardly be described as practical. Therefore, Appendix ZB of DIN VDE 0100-551 (VDE 0100 Part 551):1997-08 makes provision for a form of protection called "protective separation".

The requirements are as follows:

- a) *"Unless the low-voltage generating set has been designed as protection class I equipment or has an equivalent insulating system, the body must be connected to the unearthed equipotential bonding system."*
- b) *"If several items of current-using equipment are connected to one generating set, the requirements of either 1) or 2) must be met*
 - 1) *"If the insulation resistance between the live parts and unearthed equipotential bonding conductor drops below 100 ohms per V of nominal voltage (= 23 kΩ at 230 V), the circuits of the current-using equipment must automatically disconnect from the generating set within 1 s. Limitation of the extension of the supply system and compliance with disconnect conditions are not required if two faults occur."*

In practice, this means:

- *protection in the form of "protective separation with insulation monitoring and disconnection"*
 - *No earth rod required*
 - *The protective measure does not have to be controlled by an electrical technician; work can start immediately at any workstation.*
 - *Insulation faults are detected and result in a disconnection.*
 - *No limitation of the extension of the supply system*
- Compliance with disconnect conditions not required in the event of a second fault*



2) *“The overall length of the conductors and cables must be limited to ensure that the product of the nominal voltage in volts and overall length in metres does not exceed 100,000. However, the overall length of the conductors and cables must not exceed 500 m and one of the two requirements below must also be met.”*

- *“If two faults occur, disconnection in accordance with HD 384.4.41 S2, Section 413.5.3.4 will be required.”*
- *“If two faults occur, regardless of their location, the voltage at the terminals of the live generator set conductors must drop to < 50 V. The fault current circuit on which this must be based is the one with separate insulation faults at two different consumers that results in the highest equipotential bonding conductor resistance values.”*

In practice, this means:

- *Disconnect conditions must be observed (cable length restricted to 500 m, loop resistance must be observed)*
- *Reduction in voltage to < 50 V in the event of two faults*

Of the two options, “protective separation with insulation monitoring and disconnection” is the more practical one.

The advantages:

- Better protection for personnel and equipment when mobile generators are used to power electrical equipment
- No restrictions in terms of the number of loads and cable length
- No earth rod required
No need to penetrate difficult substrates such as rock, concrete, asphalt
- No electrically skilled person required for the purpose of calibrating the protective measure – This saves you time and labour costs
- Ready for immediate use
e.g. by the emergency services as part of rescue missions, on construction sites, for pipeline construction purposes and in many other contexts
- Timely disconnection in the event of danger by detecting insulation faults as soon as they start to occur
- Straightforward functional testing during commissioning simply by pressing the test button

Protective measures in a pipeline construction context in accordance with GW308

The use of mobile emergency generators on pipeline construction sites is covered by technical bulletin GW308 issued by the DVGW (The German Technical and Scientific Association for Gas and Water).

This stipulates that in order for the emergency generators to be universally suitable for all pipeline construction sites, protection against electric shock must be implemented in a way that also meets the requirements of work in conductive areas where there is only limited freedom of movement.

This objective is achieved by using "protective separation with insulation monitoring and disconnection".

- In line with this protective measure, the emergency generator must be equipped with a motor protection switch which is used as an isolating switch and has an electrical tripping device as well as an insulation monitoring device.

The following requirements must be met in detail:

- The earthing contacts on the socket must be connected to one another, to the housing of the emergency generator, to the emergency generator and to the insulation monitoring device by means of an equipotential bonding conductor.
- The generator's neutral conductor must not be connected to the equipotential bonding conductor.
- A circuit breaker must be installed for each of the consumer installation's socket outlet circuits and each CB must feature overcurrent and short-circuit tripping for the neutral conductor. The max. permissible rated current of the individual sockets is 32 A.
- An insulation monitoring device with a test button must be installed which is capable of ensuring that the equipment can be disconnected from the generator with a maximum response time of one second (measured in accordance with IEC 61557-8) if the insulation resistance should drop to below 100 ohms/V.
- The insulation monitoring device must meet the requirements of IEC 61557-8.

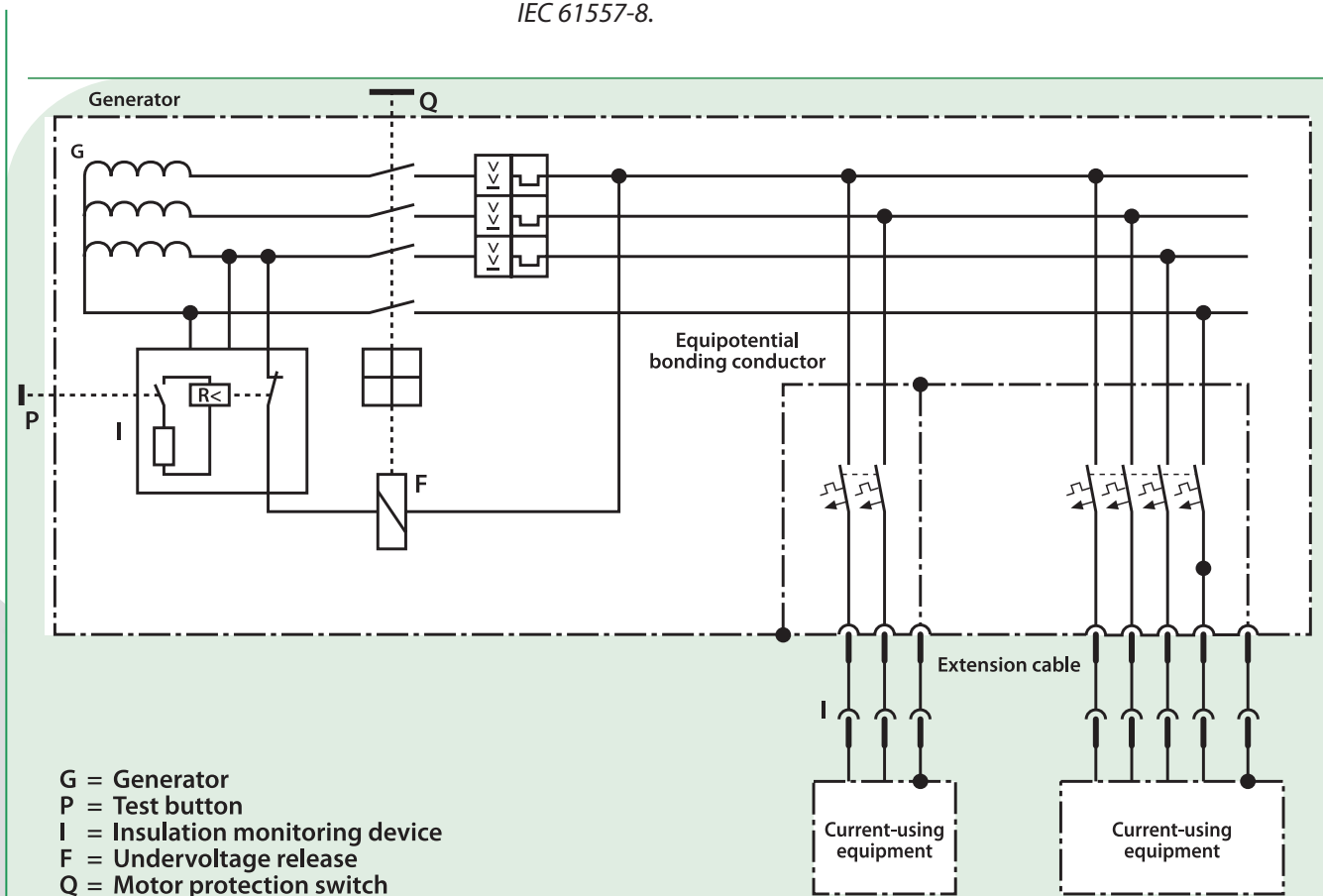

Mobile power generator in accordance with GW308 featuring protective separation, insulation monitoring and shutdown

Generators with a power rating > 12 kVA permanently installed in switch cabinets for firefighting vehicles

DIN 14686: 2003-10 describes the requirements of switch cabinets for fixed generators with a power rating > 12 kVA that are used in the case of firefighting vehicles

Protection against electric shock must be implemented in accordance with DIN VDE 0100-551 (VDE 0100 Part 551): 1997-08 Appendix ZB Section 551.4.4.2 Protective separation

This means that "protective separation with insulation monitoring and disconnection" can again be used as a protective measure in this case.

DIN 14686: 2003-10 also stipulates the following:

- If the insulation resistance between the live parts and unearthed equipotential bonding conductor should drop below 150 ohms/V , this must be signalled both visually and audibly; it must be possible to acknowledge the audible signal. The audible signal must be clear and sufficiently distinguishable from any background noise.
- The "protective separation with several items of current-using equipment" protective measure must be implemented in such a way as to ensure that a single-phase emergency socket will continue to be supplied with power following a disconnection. The emergency socket must be marked clearly and indelibly in such a way as to ensure that only one item of current-using equipment can be connected.

In practice, this means that:

- A two-stage insulation monitoring device must be installed (alarm at $\leq 150 \text{ } \Omega/\text{V}$) in accordance with DIN 14686 and disconnection at $\leq 100 \text{ } \Omega/\text{V}$ (DIN VDE 0100-551: 1997-08).
- An emergency socket must be installed that will remain ready for operation even in the event of an insulation fault. Only one electrical load may be connected to this socket. In other words, action must be taken to ensure that only one item of current-using equipment is connected (affix labels, give instructions and carry out checks accordingly).

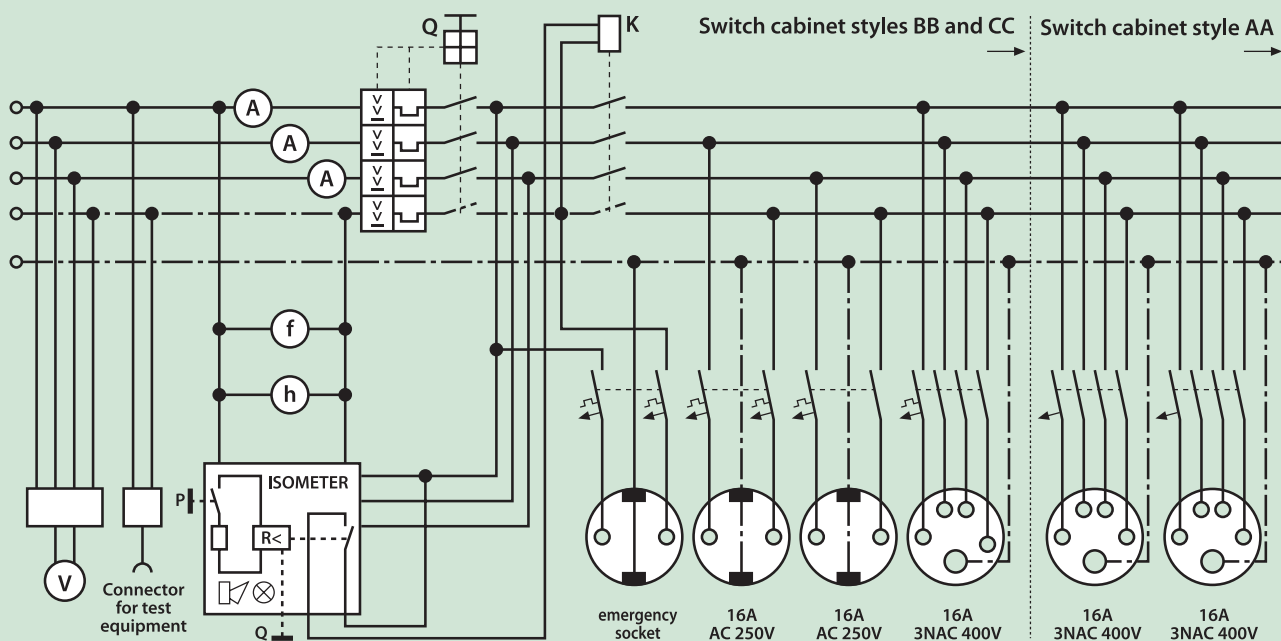

Example structure of a switch cabinet on board a firefighting vehicle in accordance with DIN 14686: 2003-10

Equipment overview of safety distribution boxes and A-ISOMETER® for mobile power generators



Safety distribution board VG12

Safety distribution box VG12

Safety distribution box for retrofitting mobile power generators up to 16 A. Structure:

- Insulation monitoring device
- Two socket outlets with earthing contact
- Switching device
- Insulation monitoring reset and test button
- Connection via plugs with earthing contact
- Assembly possible without electrically skilled person



Safety distribution board VG20

Safety distribution box VG20

Safety distribution board for retrofitting single-phase and three-phase power generators. Structure:

- Insulation monitoring device
- Switching device
- Insulation monitoring reset and test button
- Terminals

Must be installed by electrically skilled person



Safety distribution board VG30

Safety distribution box VG30

Safety distribution board for retrofitting single-phase power generators. Structure:

- Insulation monitoring device
- Switching device
- Insulation monitoring reset and test button
- Three socket outlets with earthing contact
- Connecting cable

Must be installed by electrically skilled person



A-ISOMETER® IR423

A-ISOMETER® IR423

The A-ISOMETER® IR423 is used to monitor the insulation resistance of mobile power generators in cases where the principle of “protective separation with insulation monitoring and disconnection” has been applied.

These units are primarily used for the initial equipping of mobile power generators.

- Nominal voltage AC 230 V
- Adjustable response value, 1 to 200 kΩ
- Integrated test and reset button
- Can be mounted on a DIN rail

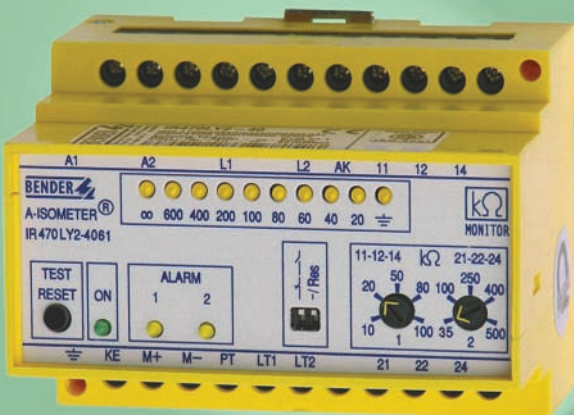

A-ISOMETER® IR470LY2-4061

A-ISOMETER® IR470LY2-4061

The A-ISOMETER® IR470LY2-4061 is used to monitor the insulation resistance of mobile power generators in cases where the principle of “protective separation with insulation monitoring and disconnection” has been applied.

These units are intended for use in switch cabinets on board firefighting vehicles with permanently installed generators with a power rating > 12 kVA.

Their two-stage signalling system enables a response value of 100 ohms/V and a value of 150 ohms/V to be set.

Technical and ordering data



Series

Type	Safety distribution box VG12	Safety distribution box VG20
Field of application		
Nominal voltage U_n	AC 230 V	3(N) AC 400/230 V
Nominal current I_n	16 A	32 A
Frequency range f_n	50...400 Hz	50...400 Hz
Function	Safety distribution box	Safety distribution box
Application		
Retrofitting 1ph power generators	×	×
Retrofitting 3ph power generators	--	×
Initial equipping of mobile power generators	--	--
Switch cabinets on board fire-brigade vehicles	--	--
Applicable standard		
DIN VDE 0100-551	×	×
DIN 14686: 2003-10 Switch cabinets for fixed generators > 12 kVA in fire-brigade vehicles	--	--
Response values/contacts		
No. of response values	1	1
Insulation monitoring response value	23 k Ω	23/40 k Ω
General features		
Test/reset button	Integrated	Integrated
"Insulation fault" indicator lamp	×	×
Fault memory	×	×
Integrated socket outlets with earthing contact	2	--
Connection	Plugs with earthing contact	Screw-type terminals
Enclosure	134 x 170 x 99 (H x W x D)	136 x 246 x 87 (H x W x D)



Safety distribution box VG30



IR423

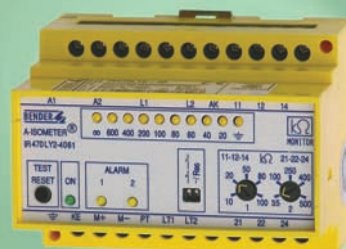

IR470LY2-4061

AC 230 V	AC 230 V	3(N) AC 400/230 V
25 A	Depends on switching device	Depends on switching device
50...400 Hz	30...460 Hz	50...400 Hz
Safety distribution box	Insulation monitoring device	Insulation monitoring device
×	--	--
×	--	--
--	×	--
--	--	×
×	×	×
--	--	×
1	2	2
10...100 kΩ	1...200 kΩ	10...100/35...500 kΩ
Integrated	integrated	integrated
×	2	×
×	×	×
3	--	--
Plugs with earthing contact	Screw-type terminals	Screw-type terminals
163 x 264 x 120 mm (H x W x D)	XM420	X470 – 73 x 99 x 70 mm (H x W x D)

Ordering information

Type	Nominal voltage U_n	Nominal Current I_n	Response value (kΩhm)	Art. No.
VG12	AC 230 V	16 A	23 kΩhm	B 980 853
VG20	3NAC 400 / 230 V	32 A	23 / 40 kΩhm	B 980 822
VG30	AC 230 V	25 A	23 kΩhm	B 980 847
IR423-D4-2	AC 0...276 V	--	1...200 kΩhm	B 9101 6305
IR470LY2-4061	AC / 3(N)AC 0...690 V	--	10...100 / 35...500 kΩhm	B 9104 8052

The individual programme that meets your expectations: Designed for electrical safety – to meet every requirement – for every application

For more than 60 years BENDER innovative measuring and monitoring systems are monitoring power supplies and provide early warning of critical operating conditions in many sectors

- Power supply in industrial, residential and functional buildings
- Machines and systems in production processes
- Power generation and distribution systems
- Information and communication technology systems

Electrical safety for unearthed power supplies

- Insulation monitoring devices A-ISOMETER®
- Insulation fault location systems EDS
- Earth fault relays

Electrical safety for earthed power supplies

- Residual current monitors RCM, RCMA
- Residual current monitoring systems RCMS
- for AC, pulsed DC and smooth DC currents (AC / DC sensitive)

Power supply for medically used rooms

- MEDICS®-Switchover and monitoring modules for medically used rooms in accordance with DIN VDE 0100-710:2002-11 and IEC 60364-7-710: 2002-11
- Remote alarm indicator and operator panels
- Complete distribution systems
- IT system transformers

Measuring and monitoring relays

- for electrical quantities: current, voltage, phase sequence, frequency, etc.
- for special applications such as mining, mobile generators, welding robots, solar photovoltaic systems and many more

Communication solutions

- Protocol converter for standard bus systems (PROFIBUS, Modbus), Protocol converter for Ethernet/TCP/IP
- Visualization of data via Axeda Wizcon and Active X
- Communication via OPC

Testing systems

- for electrical safety of medical electrical devices and general electrical equipment
- Function testers for medical electrical equipment
- Equipment management software

Service

- Function check, EMC check, system quality check
- Electro thermography, commissioning, periodic testing
- Technical approvals of electrical installations by recognized experts, inventory taking/maintenance of installations
- Modernization, central building control systems / visualization, on-site training courses
- Fault elimination, insulation fault location



Dipl.-Ing. W. Bender GmbH & Co. KG

P.O. Box 1161 • 35301 Grünberg • Germany

Londorfer Straße 65 • 35305 Grünberg • Germany

Tel.: (06401) 807-0 • Fax: (06401) 807259

E-Mail: info@bender-de.com • www.bender-de.com

Power in electrical safety

Member of the **BENDER GROUP**

Änderungen vorbehalten! – 2128en/10.07/2000/Schw/JD-Druck
© Dipl.-Ing. W. Bender GmbH & Co. KG, Germany