

Operating Manual

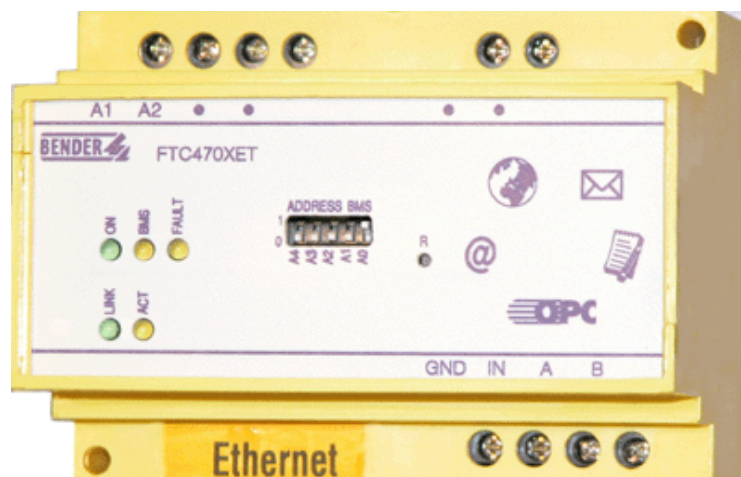

FTC470XET

Protocol converter for the connection of the
Bender measuring interface to the
TCP/IP network via Ethernet
Software version D177 V2.3x



Dipl.-Ing. W. Bender GmbH & Co. KG
Londorfer Str. 65 • 35305 Grünberg • Germany
Postfach 1161 • 35301 Grünberg • Germany

Tel.: +49 6401 807-0
Fax: +49 6401 807-259

E-mail: info@bender-de.com
Web server: <http://www.bender-de.com>

BENDER Group

© Dipl.-Ing. W. Bender GmbH & Co. KG

All rights reserved.
Reprinting only with permission
of the publisher.
Subject to change!

Table of Contents

1. How to use this documentation effectively	7
1.1 How to use this manual	7
1.2 Chapters at a glance	7
1.3 Quick reference guide	8
2. Safety instructions	9
2.1 Work activities on electrical installations	9
2.2 Address setting	9
3. Bus coupling	11
3.1 Minimal system	11
3.2 Standard application	12
3.3 Restrictions	12
4. The FTC470XET protocol converter	13
4.1 Scope of delivery	13
4.2 Features	13
4.3 Display and operating elements	14
4.3.1 LED status indication	14
4.3.2 Address-DIP switch and Reset micro pushbutton	15
4.4 BMS side of the FTC470XET	16
4.4.1 Alarm and operating messages	16
4.4.2 Diagnostics and parameterisation	16
4.4.3 Redundant master function	16
4.4.4 FTC470XET in slave mode	16
4.5 Ethernet side of the FTC470XET	17
4.5.1 Communication between Ethernet/TCP/IP interface and the BMS bus	17
4.6 Intended use	17
5. Installation	19
5.1 Basic configuration	19
5.1.1 Preparations	19
5.1.2 Setting the BMS address	19

5.1.3	Adapting a single PC to the network parameters of the FTC470XET	20
5.1.4	Setting the IP address and network mask of the FTC470XET	21
5.1.5	Resetting the network parameters to factory setting	22
5.2	Mounting and connection of the device	23
5.2.1	Wiring diagram	24
6.	The user interface of the internal Web server	25
6.1	Web browser	25
6.2	User interface structure	27
6.3	The BMS explorer	28
6.3.1	Operation of the BMS explorer	28
6.3.2	Three level hierarchically granted access rights with password protection	28
6.3.3	Standard menu, not password-protected	30
6.3.4	Submenu for the parameterisation of FTC470XET, password-protected	31
6.4	The monitoring and parameterisation frame	32
6.4.1	Calling up the menus and submenus	32
6.4.2	Alarms and prewarnings highlighted in colours	32
6.4.3	Input devices	33
6.4.4	Sequence of the menu item description	33
6.5	Main menu functions	34
6.5.1	The start page	34
6.5.2	Language selection for the user interface	34
6.5.3	Password for parameter setting	34
6.5.4	System overview	34
6.5.5	Current alarm messages	34
6.5.6	History memory	35
6.5.7	Data logger	35
6.5.8	Activating previously configured Intranet/Internet or e-mail addresses (optional)	36
6.6	The functions of the FTC470XET submenu	37
6.6.1	Device information query	37
6.6.2	System description query	37
6.6.3	System logger query	37
6.6.4	Device parameter setting	37
6.6.5	Entering system description	37
6.6.6	Data logger setting	38
6.6.7	History memory setting	38
6.6.8	System logger setting	38
6.6.9	Device monitoring setting	39
6.6.10	Translation of previously used terms into any target language	39
6.6.11	Storing two addresses in Internet format (enter URL for Links)	40

6.6.12	Network parameter setting	41
6.6.13	E-mail parameter setting for notification in case of alarm.	42
6.6.14	Sending a test mail	44
6.6.15	Changing the password	44
6.6.16	System software update	44
7.	Web server application examples	45
7.1	Monitoring of an RCMS470-12 connected to the BMS bus	45
7.1.1	Calculating actual measured values	46
7.1.2	Retrieving device information	46
7.1.3	Displaying collected data logger information in Excel	47
7.2	Parameter setting of an RCMS470-12 connected to the BMS bus	48
7.2.1	Disabling a measuring input	48
7.2.2	Monitoring an N conductor for undercurrent	49
7.2.3	CT connection monitoring parameter setting	49
7.2.4	Setting a CT correction factor	50
7.2.5	Discriminator circuit with RCMS470-12 (Monitoring a "window")	51
7.2.6	Changing an alarm text or a measuring point description	52
7.3	Monitoring an IRDH275B connected to the BMS bus	53
7.4	Parameter setting for an IRDH275B connected to the BMS bus	54
7.4.1	Setting the parameters for response values, operating principle of the relays and starting time of the automatic self test	55
8.	Application of the internal OPC server	57
8.1	Function	57
8.1.1	OPC specification	57
8.1.2	OPC data structure	57
8.2	OPC compatibility with Windows 2000 or Windows XP	58
8.3	Displaying BMS data using the OPC Demo Client	63
8.3.1	Starting the OPC client and carrying out a connection to the OPC server	63
8.3.2	Data collection of the whole BMS system via BMS addresses and channels	64
8.3.3	Compilation of the BMS addresses being monitored, BMS channels and items	65
8.3.4	Monitoring of the compiled BMS addresses, BMS channels and items	66
8.4	Channels, data types and data values of BMS devices	67
8.4.1	Alarm messages	67
8.4.2	Operating messages	70

9. How to use the FTP server	71
9.1 System software update	71
9.2 Backup of specific system files	71
10. Service and support	73
10.1 Damage in transit	73
10.2 Malfunctions	73
10.2.1 What should be checked?	73
10.2.2 Where do you get help?	73
10.3 Warranty claims	73
10.4 Warranty and liability	74
11. Technical data	75
11.1 Data in tabular form	75
11.2 Dimension diagram	76
11.3 Ordering information	77
12. Frequently asked questions:	79
INDEX	81

1. How to use this documentation effectively

1.1 How to use this manual

This operating manual will concern qualified experts in electrical engineering and communication technology!

In order to make it easier for you to find specific text passages or references in this manual and for reasons of comprehensibility, important information is emphasised by symbols. The meaning of these symbols is explained below:



Information calling attention to hazards are marked with this warning symbol.



Information intended to assist the user to make optimum use of the product are marked with the Info symbol.

1.2 Chapters at a glance

- How to use this documentation effectively
This chapter provides tips and useful information on how to use this manual.
- Safety instructions
This chapter describes the dangers during installation and when operating the device.
- Bus coupling:
This chapter deals with the normal use of this product.
- The protocol converter FTC470XET (gateway):
This chapter describes the scope of delivery, the operating and display elements available at the device, the function of the protocol converter as well as the intended use.
- Installation:
This chapter describes the device settings required to be set prior to installation and the installation itself.
- The user interface of the Web server:
This chapter describes the user interface intended to be used to check and parameterise the protocol converter FTC470XET and a BMS system connected to it.
- Application examples for the Web server:
This chapter provides examples intended to facilitate the operation of the FTC470XET.
- Use of the internal OPC server:
This chapter describes the OPC server function and its use with the help of the demo client.

- Use of the FTP server:
This chapter describes the use of the internal FTP server in the example of FTC470XET system file updates.
- Service and support:
This chapter offers service and support in case of malfunction. In addition, this chapter provides information about the technical sales department.
- Technical data:
This chapter provides an overview of technical data, a dimension diagram and ordering details.
- Frequently asked questions:
This chapter provides a list of answers to many common questions. This list will possibly help you to get all basic problems solved.

1.3 Quick reference guide

If you are familiar with networking, particularly with Ethernet, it may be helpful to start right away with "chapter 4. The FTC470XET protocol converter" and "chapter 5. Installation". In chapter 4 you will find information about display and operating elements as well as interfaces. Chapter 5 provides information about the basic configuration, installation and the connection of FTC470XET.

2. Safety instructions

2.1 Work activities on electrical installations

- All work activities necessary for installation, commissioning or work activities during operation of electrical devices or systems are to be carried out by adequately skilled personnel.
- Observe the relevant regulations applying to work on electrical installations, in particular EN 50110 or its subsequent regulation.



Unprofessional work activities on electrical installations may result in a threat of danger to the life and health of human beings!

- If the equipment is used outside the Federal Republic of Germany, the respective national standards and regulations are to be observed. The European standard EN 50110 is recommended to be used as a directive.

2.2 Address setting

A prerequisite for proper functioning of the FTC470XET protocol converter is its correct address setting.



Assigning addresses that are already used by existing devices in the BMS or TCP/IP network concerned may cause serious malfunctions.

Ensure correct address setting at the FTC470XET. For details refer to the chapter basic configuration beginning with page 19.

3. Bus coupling

BENDER devices with bus interface communicate with each other via the Bender measuring device interface (BMS bus). The FTC470XET allows data exchange between the BMS bus and TCP/IP based networks via Ethernet.

This protocol converter enables you to query and parameterise Bender devices connected to the BMS bus or single user PCs via Internet or local computer networks.

3.1 Minimal system

At least, the following components are required to operate an FTC470XET:

- A network-capable computer with Ethernet connection and a frame-capable Web browser. The FTC470XET user interface has been optimised for displays with a resolution of 1024 x 768 pixels.
- An Ethernet connection with a cross over patch cable, STP, RJ45 plug.
- Suitable IP addresses for communication between the computer and the FTC470XET. Both devices must have IP addresses of the same address range and identical network masks.

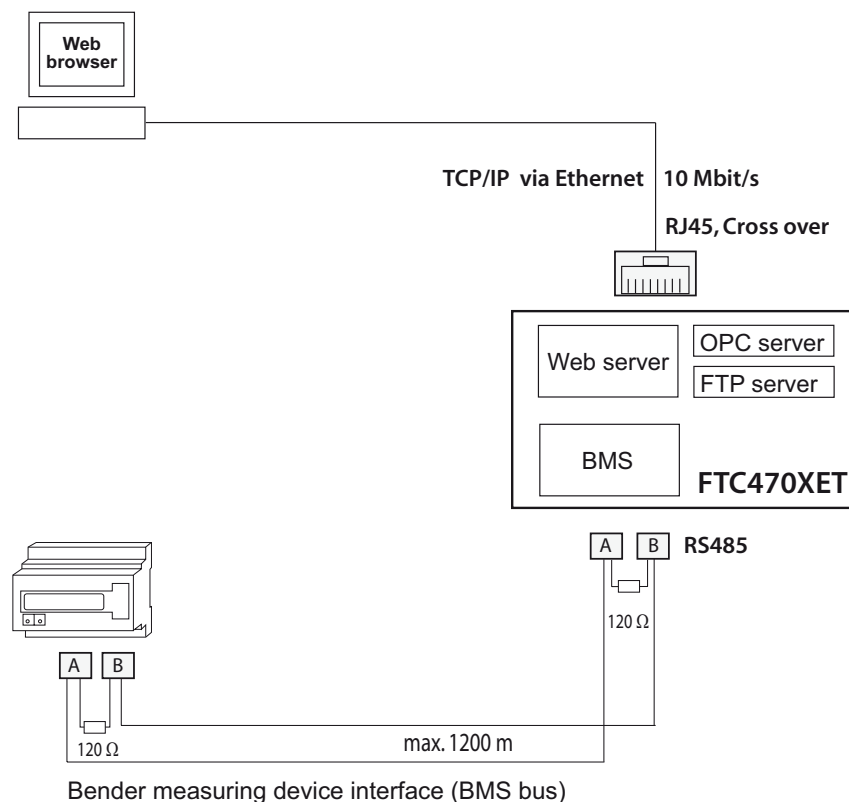

Fig. 3.1: Minimal system to operate an FTC470XET

3.2 Standard application

In order to use BMS data, connect the internal FTC470XET Web server via the Ethernet/TCP/IP interface to the local TCP/IP network (LAN), for example. Then the internal Web server can be queried and parameterised with frame-capable Web browsers. The diagram below shows how to access BMS devices via Internet and from a local network.

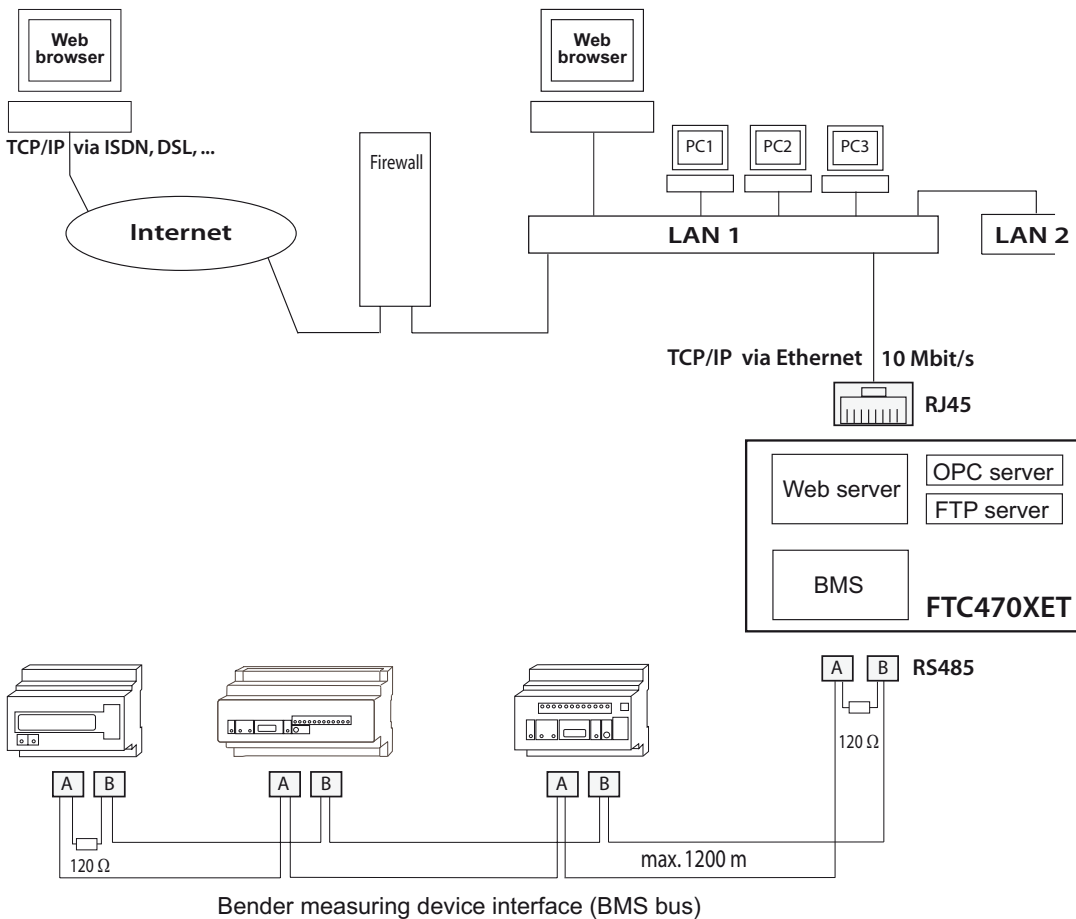

Fig. 3.2: Block diagram of a BMS bus and Ethernet coupling

3.3 Restrictions

Bender devices, such as TM panels or PRC1470, use in addition to the internal interface an external BMS interface capable of connecting the devices to extended external BMS networks. This external interface **cannot** be addressed by the FTC470XET.

TM operator panels or PRC1470 in BMS networks only can communicate with the FTC470XET via their internal interface, parameter setting is not possible!

4. The FTC470XET protocol converter

This chapter describes

- the scope of delivery
- the features
- the operating and display elements of the device
- the function of the protocol converter (gateways)
- the intended use

4.1 Scope of delivery

Included are:

- the FTC470XET protocol converter
- the operating manual

4.2 Features

A compact design has been realised for the Web server implemented for test, service and parameterisation purposes. Its capacity therefore is restricted.

- Compact Web server for test, service and parameterisation purposes with restricted functionality.
- Connects TCP/IP networks to the BMS bus via Ethernet: hardware solution with firmware, no additional special software required.
- Internal Web server for the provision of all the BMS data, retrievable via frame-capable Web browsers, optimised for a monitor resolution of 1024 x 768 pixels.
- Three-plus-one-language user interface: English, German, French and one operator-settable language.
- Automatic recognition of all addresses existing on the BMS bus.
- Channel-related indication of the currently measured values of each BMS device: Alarm, operating and status messages.
- Display of the system characteristics of the respective BMS device, e.g. measuring point description, alarm texts designed as required.
- Parameterisation of the devices on the BMS bus.
- Storage and display of the alarm messages in the history memory : Memory for up to 600 data records.
- Log function for measured values: 20 Data loggers for up to 600 records each.
- E-mail notification in case of alarms and system faults.
- Hierarchically granted access rights with password protection.
- OPC server for communication with visualisation software of building control systems.
- FTP server for easy system software update.
- Remote maintenance via Internet possible.

4.3 Display and operating elements

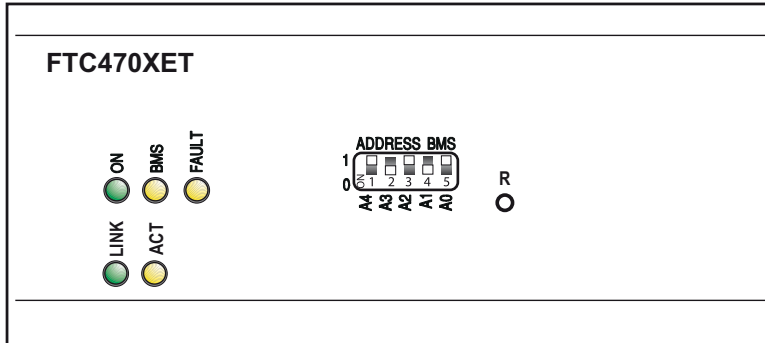

Fig. 4.1: FTC470XET front plate

4.3.1 LED status indication

LED	Meaning:
ON	Green Power ON LED lights permanently in case of correct power supply and when the device is ready for operation. Green LED flashes during the Web server start.
BMS	Yellow BMS LED signals activity on the BMS bus.
FAULT	Yellow FAULT LED lights in case of disturbances on the BMS bus, when an invalid BMS address has been set and/or in case of FTC470XET malfunctions or when there is no master on the BMS bus.
LINK	Green LED lights permanently when there is a connection to the next Ethernet node (hub, switch, router, PC, etc.).
ACT	Yellow LED signals TCP/IP data traffic.

4.3.2 Address-DIP switch and Reset micro pushbutton

The DIP switch is intended for binary BMS bus address assignment: 1-30 (1 = Master mode)



The BMS addresses 0 and 31 are not permitted to be set!

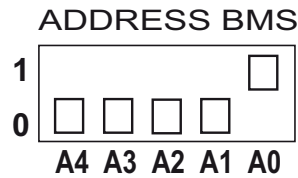

Dec. addr.	A4	A3	A2	A1	A0	Dec. addr.	A4	A3	A2	A1	A0
1	0	0	0	0	1	16	1	0	0	0	0
2	0	0	0	1	0	17	1	0	0	0	1
3	0	0	0	1	1	18	1	0	0	1	0
4	0	0	1	0	0	19	1	0	0	1	1
5	0	0	1	0	1	20	1	0	1	0	0
6	0	0	1	1	0	21	1	0	1	0	1
7	0	0	1	1	1	22	1	0	1	1	0
8	0	1	0	0	0	23	1	0	1	1	1
9	0	1	0	0	1	24	1	1	0	0	0
10	0	1	0	1	0	25	1	1	0	0	1
11	0	1	0	1	1	26	1	1	0	1	0
12	0	1	1	0	0	27	1	1	0	1	1
13	0	1	1	0	1	28	1	1	1	0	0
14	0	1	1	1	0	29	1	1	1	0	1
15	0	1	1	1	1	30	1	1	1	1	0

Tab. 4.1: Table of permissible BMS addresses

A restart can be carried out using the micro pushbutton located at the rear of the front plate (hardware reset).

4.4 BMS side of the FTC470XET

On the BMS side, the FTC470XET protocol converter can optionally be used as master or as slave.



It is recommended to prefer the master mode in order to get faster data access.

- BMS address 1 = master mode
- BMS address 2 to 30 = redundant master mode
- BMS address 2 to 30 = slave mode

The following data types are available on the BMS bus:

4.4.1 Alarm and operating messages

Bender devices connected to the BMS bus are cyclically scanned for alarm and operating messages. Each device can store up to 12 alarm and operating messages, which are organised according to the channels 1-12.

4.4.2 Diagnostics and parameterisation

This data is only sent to the bus if requested by BMS commands.

4.4.3 Redundant master function

FTC470XET provides the "Redundant master" function. In the event of failure of the regular master (bus address 1) after approximately 60 seconds this "Redundant master" takes over the master function in order to control the BMS bus. If the regular master becomes active again, the "redundant" FTC470XET returns the master function.



The FTC470XET provides the redundant master function when a BMS address between 2 and 30 has been assigned to it.

In case of failure of the regular master, first the device with BMS address 2 tries to become redundant master. If it fails to take over the master function, address 3 will be the next and so on. That means that an FTC470XET with BMS address 2 is more likely to take over the redundant master function than a device with address 30.

4.4.4 FTC470XET in slave mode

If the FTC470XET is operated in the slave mode in the existing BMS environment, one of the following devices has to act as BMS master:

- IRDH275, 375, 575 software version 1.40 or higher
- PRC1470 software version 1.82 or higher
- TM1000 software version 1.82 or higher
- FTC470XDP software version 1.31 or higher
- FTC470XET software version 1.01 or higher
- FTC470XMB software version 1.31 or higher



Please note that the FTC470XET cannot be operated in combination with a PRC470 control and indicating device!

4.5 Ethernet side of the FTC470XET

4.5.1 Communication between Ethernet/TCP/IP interface and the BMS bus

On the Ethernet side of the protocol converter various data and services are available.

- Internal Web server:
 - Representation and parameterisation of BMS data and functions is possible with frame-capable Web browsers.
 - The entire data is represented by means of HTML4.0 and JavaScript 1.0.
- Internal Email client:
 - E-mail notification in case of alarms and system faults.
- Internal OPC server
 - Provision of alarm and operating messages for the standardised OPC interface according to the specification: Data Access 2.0
- Internal FTP server
 - System software update by means of FTP data transfer.
 - Backup of the system software by means of FTP data transfer.

The Ethernet interface does not require any configuration. The TCP/IP protocol carried out via this interface, however, requires an IP address. Details about address assignment are described in chapter "Basic configuration" on page 19.

4.6 Intended use

The FTC470XET protocol converter connects the serial Bender BMS bus to a TCP/IP network via Ethernet. The converter is capable of transmitting data from the BMS bus to the TCP/IP network and vice versa.

The FTC470XET provides information from the BMS network via one internal Web browser and OPC server.

Communication with the Web server is carried out via a frame-capable Web browser. The user interface has been optimised for a resolution of 1024 x 768 pixels.

Interface on the Ethernet side:



For communication, the FTC470XET always requires a TCP/IP address.

Interface on the BMS side:

The FTC470XET can optionally be operated as master or slave.



Generally, the FTC470XET is to be operated as master on the BMS side (BMS address 1). This is the standard setting to achieve higher data throughput.

5. Installation

5.1 Basic configuration



*If you are familiar with the configuration of computer networks, you can carry out the connection of the FTC470XET by yourself. **Otherwise please contact your EDP administrator!***

5.1.1 Preparations

First consult the person in charge of the electrical installation for the addresses and net masks of the protocol converter in the respective bus structures (BMS and TCP/IP). It is also necessary to find out whether the FTC470XET can be operated as BMS master (default setting for higher data throughput).

Prior to installation and connection, an address has to be assigned to the FTC470XET. What you need is:

- A free BMS address between 2 and 30 for FTC470XET or a permission to assign the master function to the device, that means, BMS address 1 is assigned to the FTC470XET.
- A free IP address and the net mask for the FTC470XET connection to the local network intended to be used, subnetting is possible.
- Optional:
The IP address of the default gateways, DNS server, and WINS server
- A cross-over-patch cable and a straight-through-patch cable (LAN cable).
A cross-over-patch cable can be distinguished from a straight-through-patch cable by the wiring of the transparent RJ45 plugs. The sequence of colours of the parallel conductors is different.
- A PC or Laptop which at least can be operated temporarily separately from the computer network.



Assigning addresses that are already used by existing devices on the BMS or TCP/IP network can cause serious malfunctions.

5.1.2 Setting the BMS address

1. If it is possible from the technical point of view to assign the master function on the BMS bus to the FTC470XET, BMS address 1 must be used. The device will already be delivered with this factory setting.
2. Otherwise set the appropriate BMS address (2 to 30, see page 15) by means of the DIP switch according to the binary system. By way of example, address 5 corresponds to the switch positions:
A4=0 A3=0 A2=1 A1=0 A0=1

Factory setting = 1 (BMS master)

5.1.3 Adapting a single PC to the network parameters of the FTC470XET

In order to address a protocol converter, the network data of your single PC have to be adapted temporarily to the network data of the FTC470XET.

Factory setting of the FTC470XET:

IP address 192.168.0.254

net mask 255.255.255.0

For changing the default network parameters of your single PC: (e.g. with Windows 2000) proceed as follows:

1. Connect the PC to the FTC470XET with a cross-over-patch LAN cable.
2. Now open the start page using the path Start/Settings/Network and DFÜ connections. There double-click (your) LAN connection.

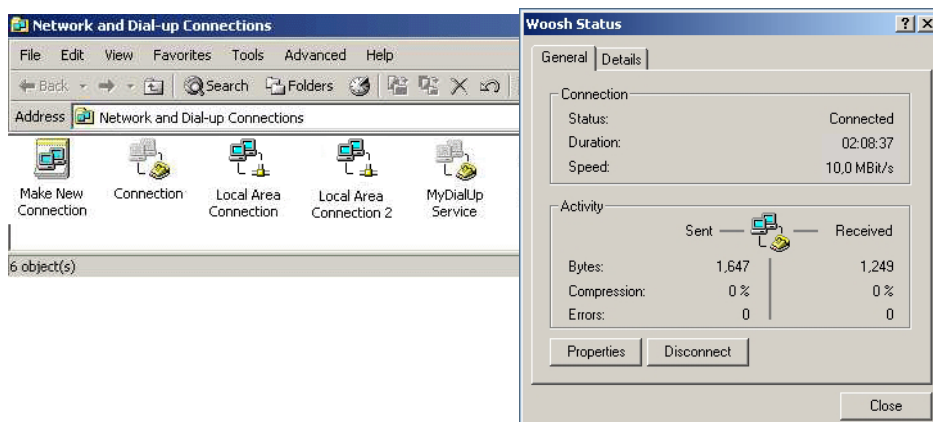

The "Status of LAN connections" screen appears.

3. Click "Properties".The "Properties of LAN connection" screen appears.
4. Double-click "Internet protocol (TCP/IP)".
The window "Properties of the Internet protocol" appears.

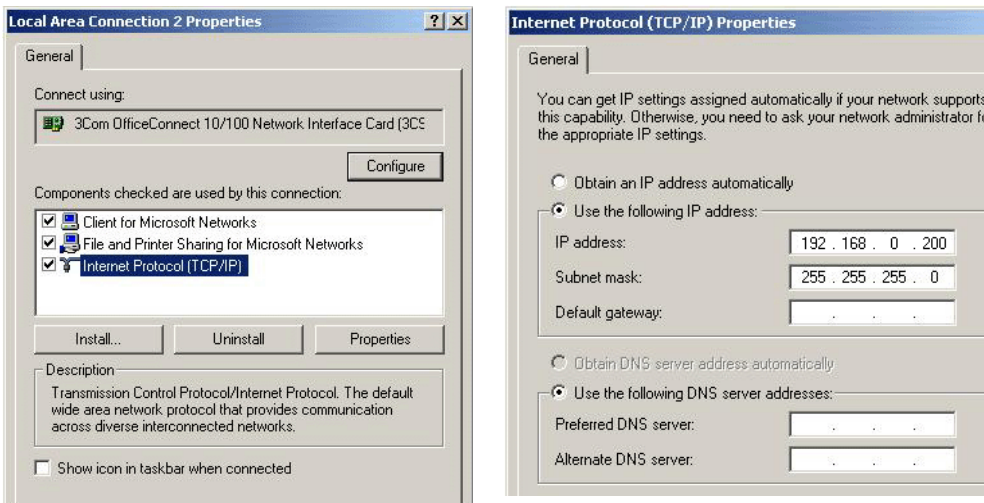

5. Enter the IP address in the associated edit field:
192.168.0.200
Use the TAB key or the mouse, if required, in order to go the next enter position.
Usually, the associated network mask appears automatically. If not, enter the IP address manually:
255.255.255.0

Confirm your correct entries with "OK". Close the other windows with OK, if required with "Close".
After adapting your PC to the network parameters of the FTC470XET, the PC can address the protocol converter by means of the Web browser (Internet Explorer etc.).

5.1.4 Setting the IP address and network mask of the FTC470XET

The following settings can be carried out in two steps.

First address the protocol converter with its factory-set IP address.

Then call up the parameterisation window in order to assign a new IP address to the device for its network environment.

Proceed as follows:

1. As soon as the green LEDs LINK and ON light permanently, you can proceed.
2. Start the browser of your PC. Enter the following address into the address field of the browser:
`http://192.168.0.254`
When each step of the procedure described above is correctly performed, the start page of the internal Web server appears.
3. Click on "Password for parameter setting"
Enter the password into the edit field: `ftc`
Confirm with "Send"
Now you have access to the parameterisation functions.
4. Click FTC470XET (mostly address 1) in the BMS Explorer in order to view the sub menu items. Then select "Set network parameters", the appropriate window will appear.
5. By way of example, it is assumed that you have received the following network data for the FTC470XET from the person responsible for the installation:
IP address: 172.16.10.54
Network mask: 255.255.0.0
Enter these data into the white edit fields.

Set network parameters		
Function	Value	New value
IpAddress:	192.168.0.254	<input type="text" value="172"/> . <input type="text" value="16"/> . <input type="text" value="10"/> . <input type="text" value="54"/>
Subnetmask:	255.255.255.0	<input type="text" value="255"/> . <input type="text" value="255"/> . <input type="text" value="0"/> . <input type="text" value="0"/>
DefaultGateway:		<input type="text"/> . <input type="text"/> . <input type="text"/> . <input type="text"/>
Primary DNS:		<input type="text"/> . <input type="text"/> . <input type="text"/> . <input type="text"/>
Secondary DNS:		<input type="text"/> . <input type="text"/> . <input type="text"/> . <input type="text"/>
Primary WINS:		<input type="text"/> . <input type="text"/> . <input type="text"/> . <input type="text"/>
Secondary WINS:		<input type="text"/> . <input type="text"/> . <input type="text"/> . <input type="text"/>
		<input type="button" value="cancel"/> <input type="button" value="save"/>
<input type="button" value="Restart"/>		

Confirm with "Save". After a few seconds the accepted data will be displayed.

6. Click "Restart". After approximately four seconds, the flashing ON LED at the device signals restart and the communication between the browser and the Web server is interrupted, because the Web

server is now only accessible via the new IP address. Close the browser.

After approximately 30 seconds, the FTC470XET will be ready for operation again, signalled by a permanently lit green ON LED.

7. Change the IP address and net mask of your single PC once again in order to be able to address the FTC470XET although it has got a new address.
(PC address in this example: 172.16.10.55 / 255.255.0.0).
(We recommend: Use the operating steps described in chapter 5.1.3)
Confirm your correct entries with OK. Close the other windows with OK, if required with "Close".
8. Start the browser of the PC and enter the new address of the protocol converter (in the example 172.16.10.54), in order to test the accessibility of the Web Server.

Once the accessibility is tested successfully, the protocol converter can be installed. Do not forget to reset the personal computer used for configuration to its initial network parameters.

5.1.5 Resetting the network parameters to factory setting

In individual cases, it may be necessary to reset the network parameters to factory settings. For this purpose, the FTC470XET must be ready for operation and the ON LED must light continuously.

Proceed as follows:

1. Connect the terminals GND and IN. The FAULT LED will flash.
2. In addition, press the reset button R for approximately four seconds. The LEDs ON and FAULT will flash.
3. Remove the connection between GND and IN. The FAULT LED goes out, whilst the ON LED keeps flashing.
4. When the ON LED lights continuously, the network parameters correspond to the factory setting.

After resetting the parameters to factory setting, the FTC470XET provides the following network parameters:

IP address: 192.168.0.254

Net mask 255.255.255.0

In addition, the administrator passwords are reset to `f t c`.



*Do **not** wire the terminals GND and IN permanently with a bridge. A permanently connected bridge and the Reset button pressed would automatically reset the network parameters to the factory setting. This may cause serious malfunctions in installations under operating conditions.*

5.2 Mounting and connection of the device

When the device is connected to a single personal computer, please note that a cross-over-patch cable is used to carry out work step 4.). Besides a cable and a personal computer no other components are required.

The following description is based on the assumption that the device is connected to a local network (LAN).

1. DIN rail mounting
Snap the clamping springs at the rear of the FTC470XET into place in a way that a tight and secure fit is ensured.
2. Connection to supply voltage U_S :
Connect the terminals A1 and A2 to a supply voltage of $U_S = 85$ to 275 V (AC/DC). A 6 A fuse is recommended for supply voltage protection. In case of connection to an IT system, all poles have to be protected. In case of DC voltage supply, any connection polarity can be used.
3. Connection to BMS:
Connect the terminals A and B to the BMS bus using the control cable (A to A, B to B). A suitable cable type is J-Y(St)Y 2x0.6.
If the FTC470XET is located at the end of the bus, the end of the bus must be terminated with a $120\ \Omega$ resistor. For that purpose loosen the terminals A and B in order to connect the terminating resistor in parallel.
4. Ethernet connection to a local network (hub, switch, router):
Connect the Ethernet connection socket to the respective local network using a straight through-patch cable (LAN cable). Please observe the data transmission rate of the FTC470XET: 10 Mbit/s. Connection via a Switch may be necessary.
After completion of your work, please check whether the internal Web server of the FTC470XET can be accessed by a browser. For this purpose, enter the URL into the address field of the Web browser (in the example above <http://172.16.10.54>).
When everything functions normally, the start page of the internal Web server will appear.
5. Then check whether devices connected to the BMS side can be queried.

5.2.1 Wiring diagram

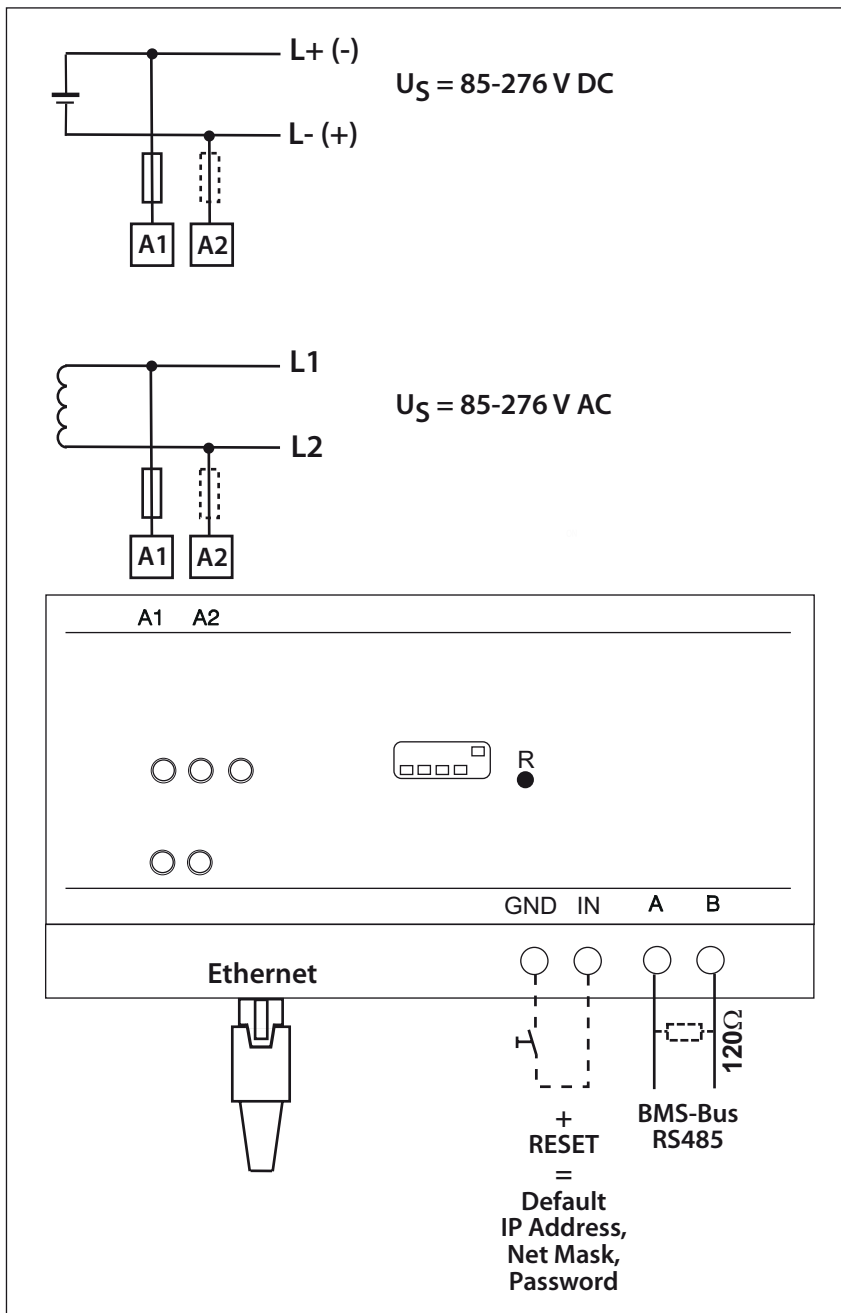

Fig. 5.1: Wiring diagram for FTC470XET



Do not wire the terminals GND and IN permanently with a bridge. A permanently connected bridge and the Reset button pressed would automatically reset the network parameters to the factory setting. This may cause serious malfunctions in installations under operating conditions.

6. The user interface of the internal Web server

Once a Web browser accesses the FTC470XET, the user interface becomes visible. The Web server is primarily used to visualise BMS data. In addition, the parameter setting of BMS devices and the protocol converter FTC470XET can be carried out via the user interface.

6.1 Web browser

A Web browser is a program for viewing pages and files written in HTML format. Besides this basic format, also JavaScript, ASP, XML, Java etc. run on this browser. The browser must be capable of representing frames.

Configuration of the browser

In order to be able to query and parameterise the FTC470XET smoothly, it is necessary to enable cookies and to minimise the security restrictions. For that purpose, set the FTC470XET IP address to "Trusted" in the security settings of your browser and allow cookies for this address.

When using the Internet explorer, minimise the security restrictions for the FTC470XET in the **security rubric**:

1. Start the Internet Explorer and open the "Internet options" window via the path Tools/Internet options. There click the security tab, unless it appears automatically.

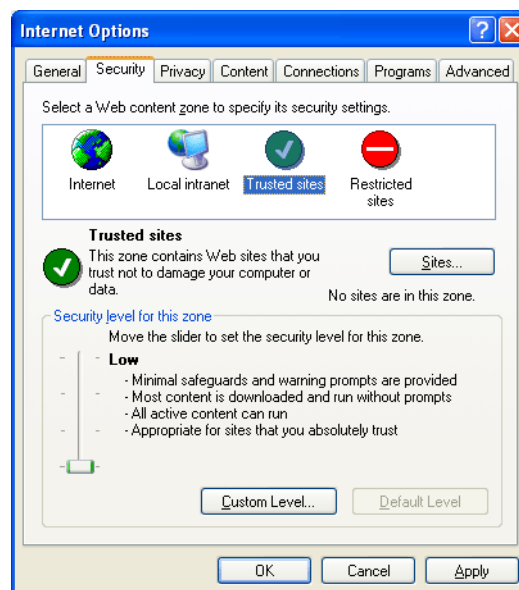

2. Click on "Trusted sites" in the white field, then press the "Sites" button". The following window appears.

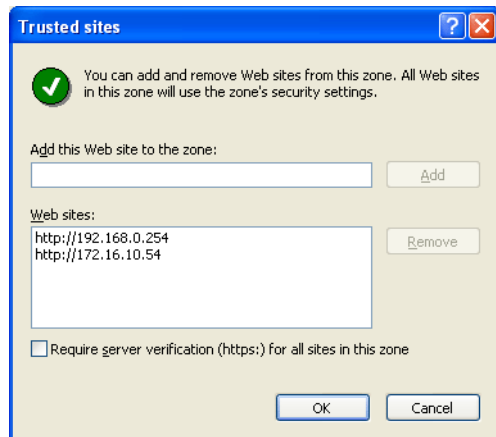

3. Enter the valid Web address of the FTC470XET into the top edit field, e.g. `http://192.168.0.254` and press "Add" Confirm with OK. The address will be added to the list below. For this reason, Web servers with listed addresses are classified as "Trusted" and are called up with low security barriers.

When using the Internet Explorer, allow the FTC470XET to use Cookies in the **Privacy rubric**:

1. Start the Internet Explorer and open the "Internet options" window via the path Tools/Internet options. There click the "Privacy" tab, unless it does not appear automatically.

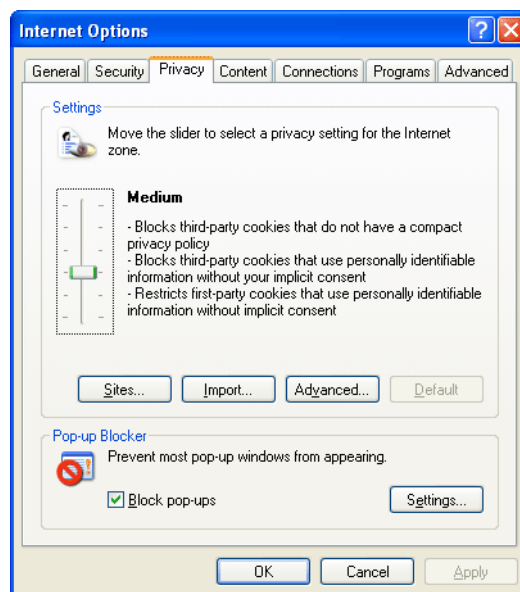

2. Click the key "Sites" . The following window appears.

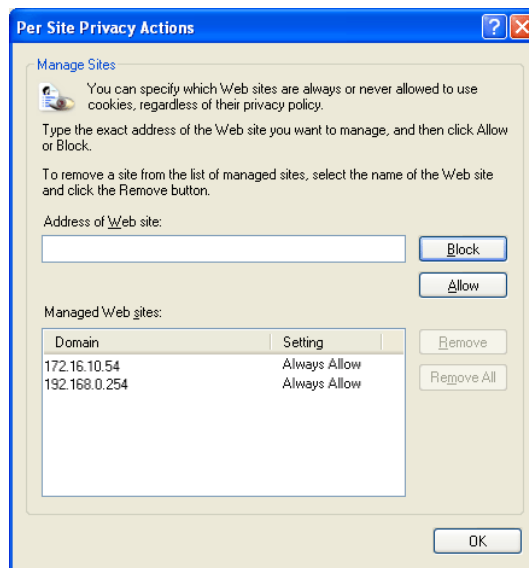

3. Enter the valid Web address of the FTC470XET into the upper edit field, z.B. http://192.168.0.254 and press "Allow". Confirm with OK. The address will be added to the list below. That allows "Cookies" to be used continuously for Web addresses listed in this field, regardless of other Cookie restrictions.

6.2 User interface structure

In addition to the passive header frame, the internal Web server provides a BMS explorer and a frame on the right for visualisation and parameterisation. The user interface is controllable via the mouse.

- The BMS explorer is the main navigation tool on the user interface.
- Visualisation and parameterisation frames
The contents of the user interface frame on the right responds to navigation steps in the BMS explorer and primarily provides measured values, messages and parameters of a BMS system being monitored in tabular form.
- The start page offers a selection of different language versions of the user interface and access rights regulations by entering different passwords.

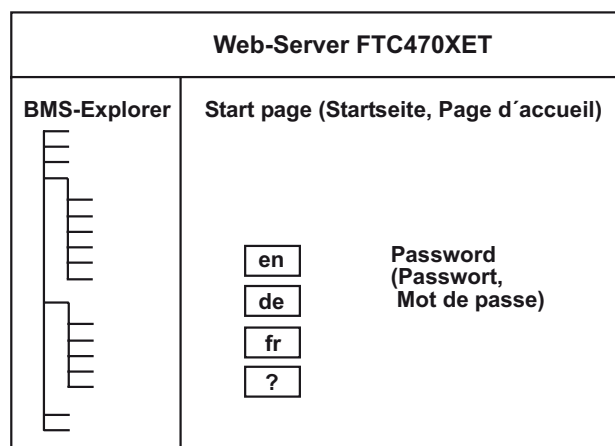
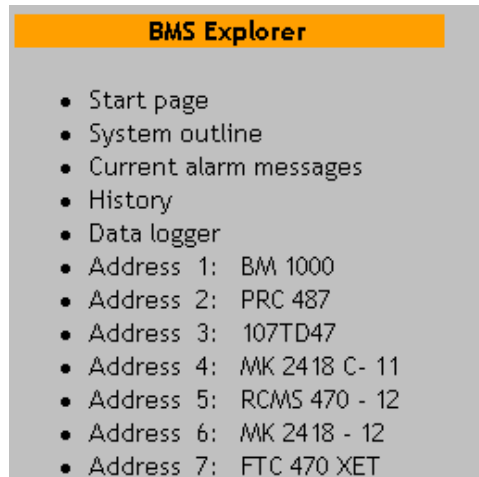

Fig. 6.1: Diagram of the user interface with start page

6.3 The BMS explorer

In the description below, the FTC470XET protocol converter and an RCMS470-12 are connected via a BMS bus and form a small bus system.

Once a Web browser displays the FTC start page, the BMS explorer becomes visible in the left column. Some of the device-related submenus are password-protected.



6.3.1 Operation of the BMS explorer

Two steps are required to carry out a specific action. Move the mouse pointer over the desired menu or submenu item so that it becomes highlighted. Your favourite menu item will turn a different colour to indicate that it is currently selected. Then activate the desired function by clicking on it. The process of the subsequent actions are illustrated in the frame to the right of it.

6.3.2 Three level hierarchically granted access rights with password protection

Submenu-default view

This menu provides access for all users for viewing all menu items of the highest level but only a few submenus with less detailed information, parameter setting is not possible. Parameter setting is carried out via submenus which are not displayed in the default view. Nearly all BMS data can be queried, a password is not required.

Submenu-view for the BMS administrator

The BMS administrator is allowed to access additionally a major part of parameterisation possibilities. Particularly critical parameters such as the setting of network parameters cannot be accessed. A BMS administrator password is required.

Submenu-view for the system administrator

The system administrator is allowed to use additional submenu items for parameter setting. He has got all access rights. He has to enter a password.

Reset to default view for submenus

By clicking the "Update" menu item in the main menu, the BMS Explorer can be reset to password-free default view for submenus. The reset process may take up to 45 s.

<i>Default view</i>	<i>BMS administrator view</i>	<i>System administrator view</i>
<p>Address 7: FTC 470 XET</p> <ul style="list-style-type: none"> ○ Device information ○ System description ○ System logger 	<p>Address 7: FTC 470 XET</p> <ul style="list-style-type: none"> ○ Device information ○ System description ○ System logger ○ Set device parameters ○ Enter system description ○ Data logger settings ○ Set history ○ Set system logger ○ Set device monitoring ○ Translation My Own Language - 1 / 3 ○ Translation My Own Language - 2 / 3 ○ Translation My Own Language - 3 / 3 	<p>Address 7: FTC 470 XET</p> <ul style="list-style-type: none"> ○ Device information ○ System description ○ System logger ○ Set device parameters ○ Enter system description ○ Data logger settings ○ Set history ○ Set system logger ○ Set device monitoring ○ Translation My Own Language - 1 / 3 ○ Translation My Own Language - 2 / 3 ○ Translation My Own Language - 3 / 3 ○ Enter URL for Hyperlinks ○ Set network parameters ○ Email settings ○ Send test mail ○ Change password ○ Software update

Tab. 6.1: Default view of submenus or password-protected administrator view

6.3.3 Standard menu, not password-protected

Menu items	Description of menu and submenu items	
	Submenu items	
Start page		Language changeover, password input for the parameterisation of the FTC470XET and further BMS devices to be monitored on the bus.
System overview		List of all devices on the BMS bus including their device addresses, device types, device descriptions and location of use.
Current alarm messages		Details on all alarms including device addresses and device channels, point of fault and measuring point; an update is carried out automatically.
History memory		Stored information about alarm messages with details on device address and channel, minimum and maximum fault values, occurrence, acknowledgement and end of the fault previously performed tests, details about the measuring point and alarm text.
Data logger		Recording of all channel-related measuring values of the previously selected BMS devices.
Bender URLs (examples)		By way of example, the URL of the Bender Websites and a virtual e-mail address has been entered (see figure on page 28)
Address 1: FTC470XET		Factory-set BMS address of the FTC470XET Submenu accessible without a password:
	Device information	Device type, software version, network parameters date, user-programmable URLs
	System description	Description of device and location
	System logger	Chronological representation of system events
Address n: Device XYZ		BMS address assigned to the respective device. Submenus of the respective devices are accessible without a password:
	currently measured values	Measured values visualised on request; an update is carried out automatically.
	Device information	Channel-related details about function, the measuring point, response value of the device, etc.
	System description	Channel-related details about the measuring point and alarm text (related to the text of the measuring sensor).
Update		Resets the BMS explorer from the password-protected menu range to default view, scans the BMS bus and recognises newly connected devices, resets the BMS explorer to default view, submenus are not reset (browser-dependent).

Tab. 6.2: Standard menu with a restricted number of submenus

6.3.4 Submenu for the parameterisation of FTC470XET, password-protected

The text and structure of the submenus on the one hand depends on the respective type of device and on the other hand on the access rights. Therefore the following table can only be taken as an example. The parameter listed in the first part of the table below can be accessed by the BMS administrator after entering his password, only the system administrator has access to all parameters.

Submenu items, password-protected	Description of the menu and submenu items
Device parameter setting	Date and time can be set here.
Entering system description	The description of the location can be changed here.
Data logger settings	In order to store the measured values, the BMS device address and the BMS channel have to be entered. In addition, the percentage measured value above which the measured value is to be logged and whether the old measured values are to be overwritten when the logger storage is completed. Up to 20 data loggers for different types and channels can be parameterised. Each Log memory can be deleted separately.
Setting the history memory	The history memory can be deleted here.
System logger setting	The memory for system events can be deleted here.
Setting the device monitoring	Select the BMS addresses of FTC470XET to be monitored for device failure. The remaining addresses should be deactivated with "No" so that unassigned addresses are blanked automatically during monitoring.
Translation My own language - 1/3 My own language - 2/3 My own language - 3/3	Here up to three lists can be filled with terminology of any language, in compliance with the terms of the languages already existing.
The following submenu items can only be accessed by the system administrator	
Entering URL for Links	Up to two Internet addresses (URLs), directly selectable from the BMS explorer and referring to different resources can be entered. References to Internet sites, e-mail addresses or files are possible.
Network parameter setting	The input of the network parameter is mandatory. Details are available in chapter "Basic configuration" on page 19. The following parameters have to be entered: IP address, netmask, default gateway, primary DNS, secondary DNS, primary WINS, secondary WINS.
Email parameter setting	For all BMS devices monitored, e-mail notifications can be sent on the occurrence of alarm messages. The message can be sent to one or two recipients. Required are details on the e-mail server, the e-mail recipient and the language version. Details can be found in chapter "E-mail parameter settings" on page 42
Sending a test mail	An e-mail can be sent here, for testing purposes.
Changing a password	The passwords for the system and BMS administrator can be changed here. For details refer to chapter "Changing a password" on page 44
Software update	This function is used to load updated software for FTC470XET to the FTP server. For details about the software transfer refer to chapter "Software update" on page 44.

Tab. 6.3: Complete submenu for parameter setting

6.4 The monitoring and parameterisation frame

The contents of this frame is controlled via the BMS explorer depending on the menu item selection.

6.4.1 Calling up the menus and submenus

The menus and submenus are called up via the BMS explorer using the mouse. For details refer to "chapter 6.3 The BMS explorer".

6.4.2 Alarms and prewarnings highlighted in colours

Prewarning messages are highlighted in yellow:

Channel	Value	Unit	Type	Measuring point
1	1400	mA	Residual current	
2	51	mA	Residual current	

Alarm messages are highlighted in red:

Channel	Value	Unit	Type	Measuring point
1	15	mA	Residual current	this is a new text
2	188	mA	Residual current	
3	182	mA	Broken Wall 3	Channel 3 (Motor 250kW)
4	-		No CT connected	
5	-		No CT connected	

6.4.3 Input devices

For monitoring or parameter setting, different tools are required.

Monitoring

For monitoring tasks, the following buttons are required:

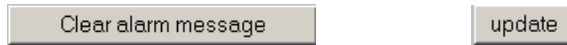

Parameter setting

There are different ways of entering the appropriate values and statuses for parameterisation. For this purpose, the user interface provides:

- Edit fields for entering texts and values.
Entries can be deleted by overwriting the previously entered text with a blank.
- Drop-down menus for the selection of texts and values.
- Buttons for starting and finishing an action, such as cancel, save and delete.

Function	Value	New value	Clear memory
Address	5	<input type="text"/>	<input type="button" value="Clear memory"/>
Channel	11	<input type="text"/>	
New value when changes [%]	0	<input type="text"/>	
Overwrite old values?	Yes	<input type="text"/>	
Address	5	<input type="text"/>	
Channel	3	<input type="text"/> <div style="border: 1px solid black; padding: 2px; width: fit-content;"> Yes No </div>	



6.4.4 Sequence of the menu item description

The sequence of the menu items described on the following pages is related to Tabelle 6.2 and the sequence of the BMS explorer. Variable menu items contain user-defined Internet addresses or directory paths which are considered as examples.

6.5 Main menu functions

6.5.1 The start page

After addressing the internal Web server using a browser, the start page appears in the frame on the right. This page on the one hand is intended to select a language for the user interface, on the other hand the password allowing the access to protected submenus can be entered here.

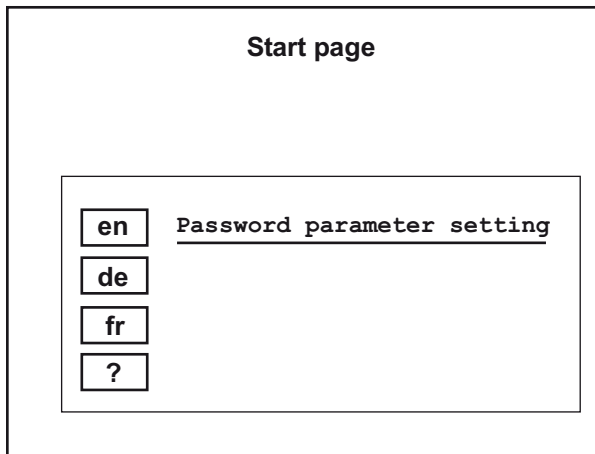

6.5.2 Language selection for the user interface

Selection options: English, German, French, freely-configurable.

Factory setting = English

If you want to use one of the other languages, press the respective button. The lowest button can be linked with any language, which of course has to be entered before. For details refer to "chapter 6.6.10 Translation of previously used terms into any target language".

6.5.3 Password for parameter setting

Factory setting for both administrators = `ftc`

Only the BMS and system administrator are allowed to set parameters. Both of them are required to enter a password.

Enter your password corresponding to your role for parameterisation. It will be confirmed and you will get access to the respective submenu.

The respective accessible submenus are described on page 31.



The password "ftc" factory-set for both administrators has to be modified by the system administrator immediately after commissioning the protocol converter. In this way, it can be ensured that neither an unauthorised user nor the BMS administrator can accidentally change the function-related network parameters.

6.5.4 System overview

After clicking this menu item, a table appears listing all devices existing on the bus, including the protocol converter. Listed are: devices with their BMS addresses, device type, description and details about the location of use.

6.5.5 Current alarm messages

After clicking this menu item, a table appears, with column headers highlighted in red, listing the current alarm messages of all devices existing on the bus. In addition to the alarm text

or alarm value, details about the source of alarm are indicated, that means the BMS address, the BMS channel and the measuring point being monitored. The alarm messages are updated automatically every 30 seconds.

Current alarm messages				
Address	Channel	Value	Alarm text	Measuring point
3	1	20 kOhm	Insulation fault	
3	3	-	Overtemperature transformer	

6.5.6 History memory

After clicking this menu item, a table appears listing up to 600 alarm messages in chronological order. From message 601 upwards, always the oldest message will be overwritten. In addition to the alarm text marked with an ID, the minimum and maximum value of the measured quantity being monitored are displayed. Furthermore, details about the source of alarm, that means the BMS address, the BMS channel and the measuring point being monitored are indicated. Also the time needed for data recording and the start and end are displayed. The columns Quit and Test show that an alarm message has been acknowledged or it has been initiated by a test.

History										
ID	Address	Channel	Min. value	Max. value	Start	Quit	End	Test	Measuring point	Text
1	5	2	188 mA	188 mA	30.06.2004 16:00:43		30.06.2004 16:00:57		Big Gray Wall V025	Residual current fault
2	5	2	188 mA	188 mA	30.06.2004 15:58:45		30.06.2004 15:59:21		Big Gray Wall V025	Residual current fault
3	5	2	188 mA	188 mA	30.06.2004 15:53:44		30.06.2004 15:54:13		Big Gray Wall V025	Residual current fault

6.5.7 Data logger

A total of 20 data loggers are available, each of them capable of recording data of one BMS channel. It doesn't make any difference whether 10 channels of a BMS device are to be logged or only one channel of 10 BMS devices. 600 data records per data logger can be recorded.

Incoming BMS messages take no priority but are stored according to the time of their occurrence.

Setting options: The percentage measuring value above or below which the measuring value is to be recorded and when the oldest data is to be overwritten in the event of a full memory. See page 38.

Data logger No: 1			
Device description:		Residual current evaluator	
Description of Location:		Big Gray Wall V025	
Measuring point:		Channel 11	
Address:		5	
Channel:		11	
ID	Date/time	Value	
1	30.06.2004 16:15:25	1656	mA
2	30.06.2004 16:14:30	1677	mA
3	30.06.2004 16:13:57	1656	mA
4	30.06.2004 16:13:24	1699	mA
5	30.06.2004 16:13:08	1656	mA
6	30.06.2004 16:12:24	1677	mA

A graphical display of the recorded data is possible by copying the values of the table into an MS Excel table, for example. By using a diagram assistant, an easily readable curve can be created. An example for such an application is illustrated on page 47.

6.5.8 Activating previously configured Intranet/Internet or e-mail addresses (optional)

If required or if it makes sense, up to two of these addresses can be stored in the FTC470XET (page 40).

Intranet/Intranet

It is possible to access preconfigured Intranet/Internet addresses by using the BMS explorer. For example, to load a technical document from the appropriate server or to get manufacturer details.

E-mail

The BMS explorer can also be used to activate a preconfigured e-mail address to contact an important partner for technical questions.

BMS Explorer
<ul style="list-style-type: none"> • Start page • System outline • Current alarm messages • History • Data logger • Bender Web Page (Example) • Email to Bender (Example) • Address 1: BM 1000 • Address 2: PRC 487 • Address 3: 107TD47

6.6 The functions of the FTC470XET submenu

The submenu items device information, system description and system logger can be used without entering a password.



All submenu items intended to be used for parameter setting require an administrator password.

6.6.1 Device information query

After calling up the submenu item "Device information", essential data of the protocol converter are displayed:

- Device type
- Software version
- Network parameters
- Date and time
- If required, the user-configured address abbreviation for Intranet/Internet or e-mail addresses (Link description), provided that the respective addresses have been previously entered under "URL for Links".

6.6.2 System description query

The submenu item "System description" provides a description about the device and location of use, e.g. gateway for BMS interface in room V027.

6.6.3 System logger query

The submenu item "System logger" provides recorded system faults such as "wrong password", "program start" or "software update".

6.6.4 Device parameter setting

The submenu item is intended to be used for setting the date and time considering the country-specific format. In addition, automatic changing to summertime can be deactivated. Valid time zone is Central European Time (MEZ) or Central European Summertime (MESZ). Other time zones are not considered. Before changing to other time zones, the summertime changeover function has to be deactivated.

6.6.5 Entering system description

This submenu item can be used to change the description of the location of the FTC470XET. It suggests itself that the device description is permanently set.

6.6.6 Data logger setting

This submenu can be used to configure up to 20 data loggers. The loggers are assigned according to the channels and BMS address. The BMS data are recorded depending on the preset percentage modification of a measuring value. It must also be specified whether the oldest data record is to be overwritten in case of a full memory. In addition, the whole storage of the logger can be deleted.

For data logger configuration, enter the following parameters into the respective edit fields:

1. The BMS device address of the device to be monitored (1 to 150);
2. The BMS channel of the previously addressed device (1 to 12);
3. The percentage measuring value above which the measuring value is to be recorded. The possible value range is 0 to 90 %;
4. Select "Yes" or "No" from the drop-down menu to overwrite the oldest data record;
5. Click "Clear memory" if you have decided to delete the previously recorded data records.
6. Confirm your actions with the button "Save" or stop your actions with "Cancel".

Data logger settings				
Data logger	Function	Value	New value	Clear memory
1	Address	5	<input type="text"/>	<input type="button" value="Clear memory"/>
	Channel	11	<input type="text"/>	
	New value when changes [%]	0	<input type="text"/>	
	Overwrite old values?	Yes	<input type="text" value="Yes"/>	

6.6.7 History memory setting

Here you have the possibility to delete history data completely.

6.6.8 System logger setting

Here, you can delete the system logger completely.

6.6.9 Device monitoring setting

A device on the BMS bus is automatically recognised by the protocol converter via its BMS bus address. You can use the submenu item "Device monitoring setting" to specify which BMS addresses are to be monitored for failure.

1. Select the BMS addresses to be monitored from the drop-down menu.
2. Confirm your actions with "Save" using the button at the bottom or stop the action with "Cancel".

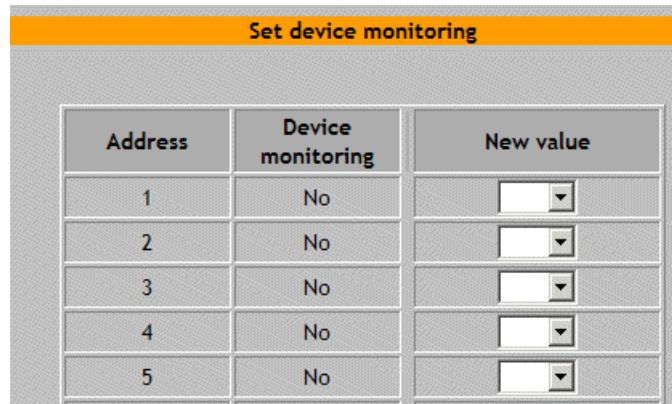

Address	Device monitoring	New value
1	No	<input type="text"/>
2	No	<input type="text"/>
3	No	<input type="text"/>
4	No	<input type="text"/>
5	No	<input type="text"/>

6.6.10 Translation of previously used terms into any target language

After activating the submenu item "Translation my own language- 1/3" , a table appears listing previously used terms in at least three different languages. These terms are used at the user interface of the protocol converter. You have the possibility to enter another language into the fourth column. You can use any characters provided that an appropriate Font is available. A total of three tables with a maximum of 768 terms can be called up via the BMS Explorer.

If you want to add terms in the desired language proceed as follows:

1. Use the BMS explorer to open one of the three windows "Translation my own language -"
2. Enter the new appropriate term into the respective field.
3. Confirm your actions with "Save" using the button at the bottom or stop the action with "Cancel".



English version	Deutsche Fassung	Version française	My Own Language	New text
English version	Deutsche Fassung	Version française	My Own Language	<input type="text"/>
Device information	Geräteinformation	Informations appareil	Информация об устройстве	<input type="text"/>
Current values	Aktuelle Messwerte	Valeurs mesurées actuelles	Актуальные величины измерения	<input type="text"/>
Current values	Aktuelle Meldungen	Messages actuels	Актуальная информация	<input type="text"/>
Response values	Ansprechwerte	Valeurs de seuil	Величина срабатывания	<input type="text"/>
CT correction factor	Korrekturfaktor Wandler	Coefficient de correction tore	Фактор поправки для трансфор.	<input type="text"/>

6.6.11 Storing two addresses in Internet format (enter URL for Links)

This function is only accessible for the system administrator after entering a password. It is possible to store two addresses or paths for different tasks, which are available in the BMS explorer.

Entering a new address:

1. Use the BMS Explorer to open the "URL for Links" window.
2. Enter an appropriate short term for the address to be stored into the edit field "Description new Link".
3. Enter an appropriate address (max. 100 characters) into the "URL new" edit field. For example:
 - for calling up the Web server:
http://www.bender-de.com
 - or for sending an e-mail:
mailto:info@bender-de.com
 - or for calling up a file:
file:///c:/service/infos/anschluss.txt
4. Confirm your actions with the button "Save" or stop your actions with "Cancel".
5. After saving, click the "BMS explorer update" button. Only then the address descriptions appear in the BMS explorer.

Enter URL for Hyperlinks		
Link	Function	Text / New text
1	Link name	Bender Web Page (Example)
	Link name new	<input type="text"/>
	URL	http://www.bender-de.com
	URL new	<input type="text"/>
2	Link name	Email to Bender (Example)
	Link name new	<input type="text"/>
	URL	http://www.bender-de.com
	URL new	<input type="text"/>

If you want delete previously stored text completely, overwrite this text with a blank and confirm with "Save".

6.6.12 Network parameter setting

This function is only accessible for the system administrator after entering a password.



This function may only be used by network experts, since wrong entries may impede the communication with the protocol converter.

At least one IP address and the associated net mask are required to be able to communicate with the protocol converter. The other parameters can optionally be entered according to their configuration. If the FTC470XET is to be connected to the computer network, in any case, the EDP administrator in charge of must be consulted.

Entering network parameters:

1. Use the BMS explorer to open the "Network parameter setting" window.
2. Enter the stipulated data of appropriate format into the edit field for IP addresses and net mask (nnn.nnn.nnn.nnn).
3. Confirm your actions with the button "Save" or stop your actions with "Cancel".
4. After saving the modified IP addresses, the protocol converter has to be restarted. Click "Restart". After approximately 60 seconds, flashing LEDs on the device signal restart. Hence, the communication between the browser and the Web server is interrupted since the Web server can only be accessed via the new IP address.
5. Enter the new IP address of the protocol converter into the address field and check whether the internal Web server is accessible.

For detailed description about network coupling refer to "chapter 5.1 Basic configuration" where the preparations for the coupling to an LAN is illustrated by way of example.

Set network parameters

Function	Value	New value
IpAddress:	172.16.60.19	<input type="text"/> . <input type="text"/> . <input type="text"/> . <input type="text"/>
Subnetmask:	255.255.0.0	<input type="text"/> . <input type="text"/> . <input type="text"/> . <input type="text"/>
DefaultGateway:	172.16.60.100	<input type="text"/> . <input type="text"/> . <input type="text"/> . <input type="text"/>
Primary DNS:	194.25.0.68	<input type="text"/> . <input type="text"/> . <input type="text"/> . <input type="text"/>
Secondary DNS:	194.25.0.60	<input type="text"/> . <input type="text"/> . <input type="text"/> . <input type="text"/>
Primary WINS:		<input type="text"/> . <input type="text"/> . <input type="text"/> . <input type="text"/>
Secondary WINS:		<input type="text"/> . <input type="text"/> . <input type="text"/> . <input type="text"/>

6.6.13 E-mail parameter setting for notification in case of alarm.

On the occurrence of alarms or system faults, e-mail notifications can automatically be sent to pre-defined addresses. The notification can be sent to an e-mail address or to a mobile phone after converting the e-mail via the Internet Service Provider ISP into SMS format. Short form can be selected for SMS delivery. By default, the message delivery function is deactivated.

Contact your provider for the following information that is required for the installation of an e-mail account. Check whether the SMTP or POP3 protocol is appropriate for authentication:

- The IP address of the SMTP server;
- The IP address of the POP3 server (optional);
- A user name;
- The appropriate password for the user name.

Use the diagram below to enter the appropriate data into the configuration mask (X = entry required):

Configuration of an alarm notification	SMTP authentication only	POP3 authentication before SMTP authentication
Enter IP address for SMTP server	X	X
Enter IP address for POP3 server		X
Enter user name for POP3/AUTH LOGIN (authentication)	X	X
Enter password for POP3/AUTH LOGIN (authentication)	X	X

Parameterisation and activation of the notification function:

1. Use the BMS explorer to open the "E-mail settings" window.
2. Switch on "Sending an e-mail" by selecting "On" from the associated drop-down menu.
3. SMTP-Server/POP3-Server:
Enter the IP address of the mail server (SMTP) that is to be used for e-mail forwarding by the protocol converter FTC470XET into the associated edit field. If your provider requires a POP3 authentication before forwarding the e-mail, also enter the IP address of this server into the respective edit field.
The ISP can also predefine identical IP addresses for the two servers.
Format: nnn . nnn . nnn . nnn
4. Recipient/2nd recipient:
You can also mix the forwarding types described below. Up to 50 characters can be entered into the edit field.

Forwarding by e-mail:

Enter the e-mail address a notification is to be forwarded to in case of fault, if necessary also the address of a second recipient.

Example: first name .@bender-de.com

Forwarding per SMS:

This way of forwarding is only possible if the conversion e-mail/SMS is supported by your ISP. Enter the special e-mail address to which the SMS is to be sent, if applicable also the special e-mail address of a second recipient. The first part of the e-mail address consists of the number of the mobile phone.

Example: 01234567890@t-d1-sms.de

5. Sender:
 You can modify the e-mail sender. Up to 50 characters may be entered into the edit field. Please make sure that the sender's e-mail account is registered with ISP.
 Factory setting = ftc470xet
 Example: ftc470xet@web.de
6. User (POP3/AUTH LOGIN):
 Enter the user name predefined by ISP in order to get access to the e-mail server/POP3 server. Up to 50 characters may be entered into the edit field.
7. Password (POP3/AUTH LOGIN):
 Enter the user name predefined by ISP in order to get access to the e-mail server/POP3 server. Enter the password again into the second edit field. Up to 50 characters can be entered into the edit field.
8. Short form for SMS
 When you have decided to send the notification as SMS in step 4, activate this function with "Yes". Notifications will be sent in short form.
9. Text:
 Choose the language version for your notification.
 Factory setting = English version
10. Set alarm address:
 Select "Yes" for the BMS addresses to which a notification is to be sent in case of alarm.
11. Confirm your actions with the "Save" button or stop your actions with "Cancel".
12. After correct setting and saving of the parameters you are recommended to check your settings by forwarding a test e-mail. For details about forwarding a test mail refer to page 44.

Email settings		
Function	Value	New value
Send Email:	On	<input type="checkbox"/>
SMTP server:	217.72.192.157	<input type="text"/> . <input type="text"/> . <input type="text"/> . <input type="text"/>
POP3 server:	217.72.192.134	<input type="text"/> . <input type="text"/> . <input type="text"/> . <input type="text"/>
Recipient:	bernhard.ernst@bender-de.com	<input type="text"/>
2. Recipient:	bender@hannovermesse.de	<input type="text"/>
Sender:	ftc470xet@web.de	<input type="text"/>
User (POP3/AUTH LOGIN):	ftc470xet@web.de	<input type="text"/>
Passwort (POP3/AUTH LOGIN):	*****	<input type="password"/>
Repeat password:	*****	<input type="password"/>
Short message for SMS:	No	<input type="checkbox"/>
Text:	English version	<input type="text"/>
Set alarm address:		
Address 1:	No	<input type="checkbox"/>
Address 2:	No	<input type="checkbox"/>

6.6.14 Sending a test mail

Use this function to check the e-mail parameter setting and the entire function for notification in case of alarm.

1. Click "Send test mail" in the BMS explorer.
2. Thereupon activate the appearing button "Send test mail".
3. After a short time, a table appears listing the success or failure of the e-mail dispatch. In case of success, the respective target address will be notified, in case of failure consult your EDP administrator.

6.6.15 Changing the password

Only the system administrator is allowed to change his password and the BMS administrator's password. He can change one of the passwords or both at the same time.

1. Go to the start page.
2. Click on "Password parameter setting".
3. Enter the valid administrator password into the edit field. After correct input it will be confirmed.
4. Click on the menu item "Address X : FTC470XET" in the BMS explorer. The associated submenu will be opened.
5. Select "Change password" from the submenu, the associated input screen will appear.

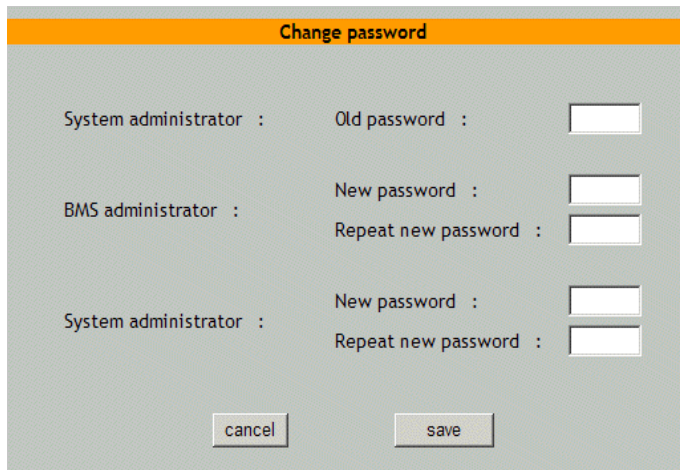

6. First enter the old administrator password, then the new one. Re-type the password into the respective input field. Click "Save" to confirm.
7. Once the password is stored, it will be confirmed.

6.6.16 System software update

The FTC470XET protocol converter offers the possibility to update the device system software. For details refer to page 71.

7. Web server application examples

By way of example, a residual current monitoring system and an insulation monitoring device are used to illustrate the parameter setting and monitoring of bus-capable devices.

7.1 Monitoring of an RCMS470-12 connected to the BMS bus

- Address 13: RCMS 470 - 12
 - Current values
 - Device information
 - System description

The menus and submenus are selected using the BMS explorer. The standard menus, as illustrated opposite, provide an overview about the configuration and the current measuring values of a system consisting of bus-capable devices. An administrator password is not required for device monitoring.

Submenu: currently measured values		
Channel 1 to 12:	Measured value	Numerical indication 1 to 9999
	Unit	in mA or A
	Type (measured value)	- overcurrent/residual current, - undercurrent in mA, A - channel deactivated - no CT connected
	Measuring point	Description of location

Submenu: Device information		
Memory:	on/off	
Relay mode:	N/O or N/C operation	
Channel 1 to 12:	Function	Overcurrent/residual current monitoring, undercurrent monitoring, disable channel
	Factor (CT correction factor)	Division by 2 to 10, multiplied by 2 to 250
	Response value	Overcurrent/residual current, undercurrent in mA, A
	Response delay time	0...25 s in 100 ms steps
	CT connection monitoring	on/off
	Measuring point	Description of location
Prewarning (channels 1...12)	n % of the response value	

Submenu: System description		
Channel 1 to 12:	Function	Measuring point, alarm text
	Text	New text

7.1.1 Calculating actual measured values

The actual measuring values of a circuit monitored by a CT are to be calculated. The CT itself is monitored by an RCMS470-12 with BMS address 5. The measuring signal is connected to channel 2.

1. Select: "Address 5: RCMS470-12" from the main menu. The respective setting submenu will appear.
2. Now click on "Current values". A list appears where you can read off the currently measured value for channel 2. You will also be informed about the location of the CT and that a residual current is flowing.

7.1.2 Retrieving device information

An RCMS470-12 with BMS address 5 has to be parameterised again after making changes in an electrical system. The current status of the function, of the response values and the CT connection monitoring have to be determined for this purpose. This data is available, amongst other data, in the "device information" window.

1. Select: "Address 5: RCMS470-12" from the main menu. The submenu required to carry out settings will appear.
2. Click on "device information". A list appears, representing data of all channels.

Device information Address : 13

Residual current evaluator

Device type: RCMS 470 - 12
 Software version: 2,1
 Memory: Off
 Relay mode: N/O operation

Channel	Function	CT correction factor	Response Value	Response delay time	CT connection monitoring	Measuring po
1	Overcurrent/residual current	* 100	300 A		Off	
2	Overcurrent/residual current	* 1	100 mA		Off	
3	Overcurrent/residual current	* 1	60 mA		On	
4	Overcurrent/residual current	* 1	100 mA		On	
5	Overcurrent/residual current	* 1	100 mA		On	
6	Overcurrent/residual current	* 1	100 mA		On	
7	Overcurrent/residual current	* 1	80 mA		On	

7.1.3 Displaying collected data logger information in Excel

Transfer the collected data from the data logger into an Excel table sheet and modify the data to display it in a diagram.

Extract from the data collection copied to Excel			Extract from the modified data collection	
06.04.2004 16:21	16	mA	16:21	16
06.04.2004 16:21	14	mA	16:21	14
06.04.2004 16:21	12	mA	16:21	12
06.04.2004 16:21	14	mA	16:21	14
06.04.2004 16:20	16	mA	16:20	16
06.04.2004 16:20	0	mA	16:20	0
06.04.2004 16:19	16	mA	16:19	16
06.04.2004 16:19	30	mA	16:19	30
06.04.2004 16:18	22	mA	16:18	22
06.04.2004 16:17	16	mA	16:17	16
06.04.2004 16:17	14	mA	16:17	14
06.04.2004 16:16	16	mA	16:16	16
06.04.2004 16:16	22	mA	16:16	22
06.04.2004 16:15	20	mA	16:15	20
06.04.2004 16:15	22	mA	16:15	22

Excel diagram created from the modified complete data collection:

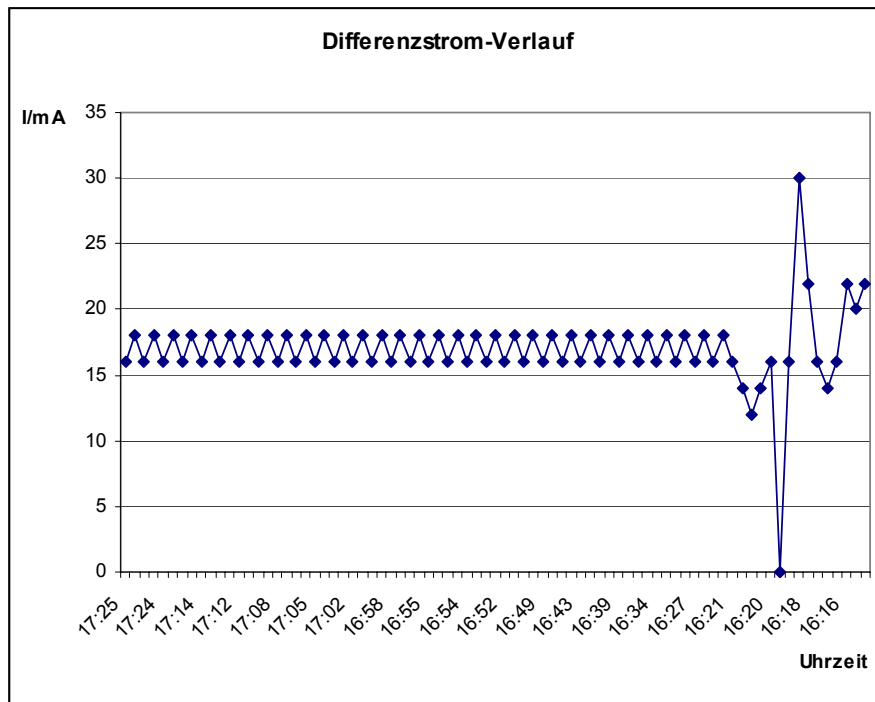

7.2 Parameter setting of an RCMS470-12 connected to the BMS bus

- Address 5: RCMS 470 - 12
 - Current values
 - Device information
 - System description
 - Set device parameter
 - Set function
 - Set response values
 - Set response delay time
 - Set CT monitoring
 - Enter system description

The menus and submenus are selected using the BMS Explorer. Using the BMS administration menu, as illustrated on the left, you can set the parameters of a bus-capable Bender device. At least one administrator password is required for parameter setting.

Prior to parameter setting, use the sub menu item "Device information" to get a general idea. The majority of the parameters of the device to be monitored can be recognised at a glance.

Prior to parameter setting, make sure that you have entered an administrator password. You cannot access the required submenu items without having administrator rights.

7.2.1 Disabling a measuring input

During maintenance in a residual-current monitored circuit, the associated CT must not be disconnected. For the duration of the maintenance operations the measuring input at channel 2 of the residual current evaluator RCMS470-12 with address 3 must be disabled.

Submenu: Set function		
Channel 1 to 12:	Function	- Overcurrent/residual current monitoring - Undercurrent monitoring - Disable channel

1. Select: "Address 3: RCMS470-12" from the main menu. The respective submenu will appear.
2. Now click on "Set function". A list displaying each channel with its associated function will appear. Channel 2 still has the function overcurrent/residual current monitoring.
3. Use the mouse to activate the drop-down menu of channel 2 and select "disable channel". Confirm your actions with the "Save" button or stop your actions with "Cancel". If "Save" has been selected, the message "Channel disabled" will appear.

Set function Address : 5		
Channel	Function	New function
1	Overcurrent/residual current	<input type="text"/>
2	Channel disabled	<input type="text"/>
3	Overcurrent/residual current	<input type="text"/>
4	Overcurrent/residual current	<input type="text"/>

7.2.2 Monitoring an N conductor for undercurrent

An neutral conductor can be monitored for interruption using the "undercurrent monitoring" function. Perform the steps as described in the preceding example above and select "Undercurrent monitoring".

Submenu: Set function		
Channel 1 to 12:	Function	- Overcurrent/residual current monitoring - Undercurrent monitoring - Disable channel

7.2.3 CT connection monitoring parameter setting

All the channels of RCMS470-12 with BMS address 5 provide a CT connection monitoring which can be set as required. By default, the monitoring of all channels (CT inputs) is enabled. In this example, channel 1 and 2 are not wired and have to be disabled.

Submenu: set CT monitoring		
Channel 1 to 12:	CT connection monitoring	- On - Off

1. Select: "Address 5: RCMS470-12" from the main menu. The respective submenu will appear..
2. Now click "Set CT connection". A list displaying each channel with its associated function will appear. For the channels 1 and CT connection monitoring is still set.
3. Use the mouse to activate the drop-down menu of the channels 1 and 2 and select "off" for each one. Confirm your actions with the "Save" button or stop your actions with "Cancel". If "Save" has been selected, the message "Off" will appear in the second column.

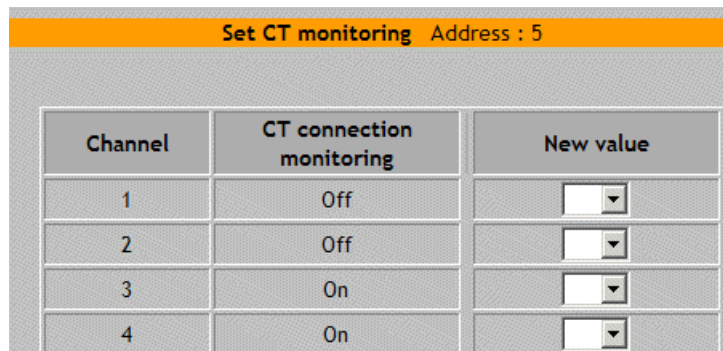

Set CT monitoring Address : 5		
Channel	CT connection monitoring	New value
1	Off	<input type="text" value="Off"/>
2	Off	<input type="text" value="Off"/>
3	On	<input type="text" value="On"/>
4	On	<input type="text" value="On"/>

7.2.4 Setting a CT correction factor

At channel 2 of an RCMS470-12 with address 5, the CT has to be replaced. The nominal current of the new CT is equal to the old one but its secondary output is 50% lower than that of the old one. The correction factor for the new CT has to be increased to 2.

Submenu: Set response value		
Channel 1 to 12:	CT correction factor	- Division by 2 to 10, - multiplied by 2 to 250.
	Response value	Overcurrent/residual current, undercurrent in mA, A
	Prewarning	Percentage value of the response value

1. Select: "Address 5: RCMS470-12" from the main menu. The required setting menu will appear..
2. Click "Set response values". A list displaying each channel with its associated CT correction factor will appear. In addition, an operator is displayed which tells you whether the factor is to be multiplied or divided. Channel 2 still has correction *1.
3. Enter correction factor 2 into the "New value" edit field. Confirm your actions with the "Save" button or stop your actions with "Cancel". If you have selected "Save", the new value "2" will appear in the column on the left.

Set response values Address : 5						
Channel	CT correction factor	CT correction factor		Response Value	Response Value	
		New type	New value		New value	Unit
1	* 1	* ▾	<input type="text"/>	10 A	<input type="text"/>	A ▾
2	* 2	* ▾	<input type="text"/>	200 mA	<input type="text"/>	mA ▾
3	* 1	* ▾	<input type="text"/>	125 mA	<input type="text"/>	mA ▾

7.2.5 Discriminator circuit with RCMS470-12 (Monitoring a "window")

The operating current on a conductor may fluctuate between 11 mA and 30 mA. When the value is outside the permissible range, an alarm is to be signalled. The conductor is monitored by one CT, the input channels 2 and 4 of the residual current monitor are connected in parallel and therefore receive the same CT signal. In order to compensate the input resistance which is divided by two, the correction factor 2 has to be set for both channels. Channel 2 has to take over the overcurrent monitoring function, channel 4 the undercurrent monitoring function. A prewarning level of 90% of the preset response value is to be set for all channels.

Submenu: Set response values		
Channel 1 to 12:	Factor (CT correction factor)	- Division by 2 to 10, - multiplied by 2 to 250.
	Response value	- Overcurrent/residual current - Undercurrent
	Prewarning	- Percentage of the response value (90%)

1. Select: "Address 5: RCMS470-12" from the main menu. The respective setting submenu will appear.
2. Click "Set response values". A list displaying each channel with its associated CT correction factor will appear. Enter correction factor *2 for both channels. Enter the response value 31 mA for channel 2 and an undercurrent response value of 10 mA for channel 4. Confirm your actions with the "Save" button or stop your actions with "Cancel". If you have selected "Save", an alarm message will be output when the upper or lower response value threshold will be reached. An example is given in the screen shots below.

Current values Address : 5				
Device description:		Residual current evaluator		
Description of Location:		Big Gray Wall V025		
Channel	Value	Unit	Type	Measuring point
1	15	mA	Residual current	
2	-		Channel disabled	
3	180	mA	Residual current fault	
4	-		No CT connected	
5	-		No CT connected	
6	-		No CT connected	
7	-		No CT connected	
8	-		No CT connected	
9	-		No CT connected	
10	-		No CT connected	
11	1656	mA	Residual current fault	
12	-		Channel disabled	

7.2.6 Changing an alarm text or a measuring point description

In some cases it may be useful to adapt an alarm text to the special local requirements. For example, if there is the requirement that an RCMS470-12 with BMS address 5 should display the message "Undercurrent" in case of undercurrent on channel 4. In addition, a description of the location of the mounted CT should be displayed.

Submenu item: Enter system description		
Channel 1 to 12:	Measuring point	- Description of location(V0.27)
	Alarm text	- Description of alarm (undercurrent)

1. Select: "Address 5: RCMS470-12" from the main menu. The required setting submenu will appear.
2. Click on "System description". A list will appear where you can type in an alarm text and a description of the measuring point for each channel.
3. Type "Undercurrent" as new alarm text into the "Type" column and "V0.27" into the "Measuring point" column. Confirm your actions with the "Save" button.
4. After calling up the "Current values" menu item, the measuring results and the associated new terms are displayed.

Channel	Value	Unit	Type	Measuring point
1	15	mA	Residual current	this is a new text
2	-		Channel disabled	
3	180	mA	Undercurrent	Channel 3 (Motor 250kW)
4	-		No CT connected	

7.3 Monitoring an IRDH275B connected to the BMS bus

- Address 9: IRDH 275B-4
- Current values
 - Device information
 - System description

The menus and submenus are selected using the BMS Explorer. The standard menus, as illustrated opposite, provide an overview about the configuration and the current measuring values of a system consisting of bus-capable devices. An administrator password is not required for device monitoring.

Submenu: Current values			
Alarm messages (highlighted red, if available)	Measured insulation resistance in kΩ	Channel 1 / channel 2 = scanned BMS channels	TEST = indication that the alarm has been triggered by a self test.
Operating messages	Measured insulation resistance in kΩ	Channel 1 / channel 2 = scanned BMS channel	
	Measured system leakage capacitance in μF	Channel 3 = scanned BMS channel	

Submenu: Device information	
Device type	e.g.: IRDH275B-4
Software version	Version No.
Response Value Alarm 1 Response Value Alarm 2	Thresholds in kΩ. IRDH275 outputs alarm messages when the values exceed or fall below the limit values.
Relay mode 1 Relay mode 2	N/O or N/C operation N/O / N/C operation Test Flash (relays switch with a cycle of 0.5 Hz)
Measuring principle	AMP / DC
Analog output	0/4...20 mA
External coupling unit	on/off
Max. leakage capacitance	150 μF / 500 μF
Self test	Period of time between two tests: 24 h / 1 h / Off
Time of test	Beginning of the self test: 00.00 h...23.00 h
Language	D / GB
Fault memory	on/off

7.4 Parameter setting for an IRDH275B connected to the BMS bus

- Address 9: IRDH 275B-4
- Current values
 - Device information
 - System description
 - Test
 - Set device parameters
 - Enter system description

The menus and submenus are selected using the BMS explorer. Using the BMS administration menu, as illustrated on the left, you can set the parameters of a bus-capable Bender device. At least one administrator password is required for parameter setting.

Prior to parameter setting, use the sub menu item "Device information" to get a general idea. The majority of the parameters of the device to be monitored can be recognised at a glance. An example of device setting is shown in the illustration below.

Device information Address : 9	
Insulation monitor	
Device type:	IRDH 275 B-4
Software version:	1,4
Response Value Alarm 1:	45 KOhm
Response Value Alarm 2:	5 KOhm
Relay mode 1:	N/O operation Test
Relay mode 2:	N/O operation Test
Measuring principle:	AMP
Analog output:	0...20 mA
External coupling unit:	Off
Max. earth leakage capacitance:	150 µF
Selftest:	1 h
Time of test:	12:00 h
Language:	GB
Memory:	Off

Prior to parameter setting, make sure that you have entered an administrator password. You cannot access the required submenu items without having administrator rights. Go to the "Start page" of the FTC470XET to enter the password.

7.4.1 Setting the parameters for response values, operating principle of the relays and starting time of the automatic self test

Higher response values R_{an1} and R_{an2} are to be assigned to an IRDH275B so that in case of higher insulation values Alarm 1 and 2 will be triggered:

$$R_{an1} = 100 \text{ k}\Omega$$

$$R_{an2} = 40 \text{ k}\Omega$$

In addition, the operating principle of both alarm relays has to be changed from "N/O operation Test" into "N/O operation", to prevent the relays from switching during the test.

Also the starting time of the self test is to be changed from 12:00 to 17:00 in order to meet the operational requirements.

1. Select "Set device parameters" from the submenu of the IRDH275. The respective window will appear.

Set device parameters Address : 9		
Function	Value	New value
Response Value Alarm 1:	45 KOhm	100
Response Value Alarm 2:	5 KOhm	40
Relay mode K1:	N/O operation Test	N/O operation
Relay mode K2:	N/O operation Test	N/O operation
Measuring principle:	AMP	
Analog output:	0...20 mA	
Max. earth leakage capacitance:	150 μ F	
Selftest:	1 h	
Time of test:	12:00 h	17:00 h
Language:	GB	
Memory:	Off	

2. Enter the appropriate response value in $\text{k}\Omega$ into the edit field at the top: 100. (The supported value range is 1...10 000 $\text{k}\Omega$).
3. Open the selection list in line 3 and line 4 by clicking the respective Down key. Click N/O operation.
4. Open the selection list in the line "Time of test" and select 17:00.
5. Click "Save". After a few seconds, the new value appears in the "New value" column of the "Set device parameters" window.

If you find a mistake after the completion of parameter setting, you can call up the "Set device parameters" window again and overwrite the wrong values and save them.

8. Application of the internal OPC server

8.1 Function

The FTC470XET contains a network-capable OPC server continuously providing the alarm and operating messages of the BMS bus being monitored. For retrieving this OPC data, an appropriate client is to be used. The data is provided by the OPC server as items. Parallel access of several clients is possible.

If devices are added to or removed from the BMS bus, the update of the OPC server data (Items) can be carried out in the following way:

- an update of the BMS explorer of the internal Web server is to be carried out or
- the FTC470XET has to be restarted.

Only then, the OPC server is able to provide the actual data.

Data available in OPC format can then also be processed using a suitable visualisation software of automation technology. BENDER uses the visualisation software Wizcon Application Studio, Axeda Systems Inc. and the application Studio from Advantech.

8.1.1 OPC specification

The FTC470XET server supports the OPC specification Data Access 2.0.

An OPC client must meet the requirements of the respective specification in order to be capable of retrieving data from the BMS bus.

8.1.2 OPC data structure

The hierarchy of the OPC data structure is as follows:

Node	= IP address of the FTC-OPC server	e.g. 172.17.60.11
Group	= can be named as required	e.g. device name, BMS address, etc.
Items	= Value Item	BMS data value
	= Type Item	BMS data type
	= Alarm Item	BMS alarm (0 or 1), (2 = device error)
	= Active Item	BMS operating state (0 or 1)

The first elements of the items are the BMS address and the respective BMS channel. The following screen shot illustrates the link of this data to the Items.

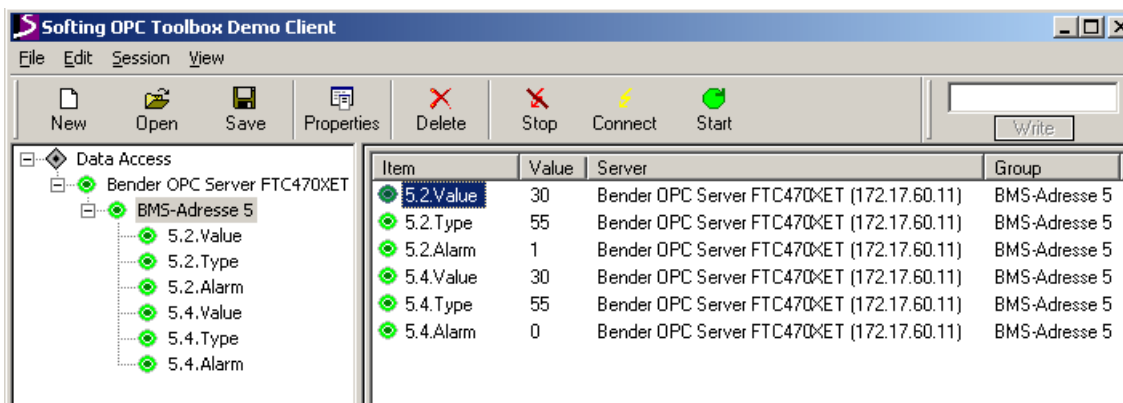

The screenshot shows the 'Softing OPC Toolbox Demo Client' interface. On the left, a tree view under 'Data Access' shows a hierarchy: 'Bender OPC Server FTC470XET' containing 'BMS-Adresse 5', which further contains '5.2.Value', '5.2.Type', '5.2.Alarm', '5.4.Value', '5.4.Type', and '5.4.Alarm'. On the right, a table displays the following data:

Item	Value	Server	Group
5.2.Value	30	Bender OPC Server FTC470XET (172.17.60.11)	BMS-Adresse 5
5.2.Type	55	Bender OPC Server FTC470XET (172.17.60.11)	BMS-Adresse 5
5.2.Alarm	1	Bender OPC Server FTC470XET (172.17.60.11)	BMS-Adresse 5
5.4.Value	30	Bender OPC Server FTC470XET (172.17.60.11)	BMS-Adresse 5
5.4.Type	55	Bender OPC Server FTC470XET (172.17.60.11)	BMS-Adresse 5
5.4.Alarm	0	Bender OPC Server FTC470XET (172.17.60.11)	BMS-Adresse 5

A summary of the correlation between the BMS device, the BMS channel No., the BMS data type and BMS data value provide the tables in "chapter 8.4 Channels, data types and data values of BMS devices".

8.2 OPC compatibility with Windows 2000 or Windows XP

The OPC software interface is based on Microsoft DCOM technology. By default, the DCOM interface of a Windows operating system is protected. If a connection between a Windows-based PC and an OPC server cannot be established, some restrictions of the DCOM interface have to be removed.

For these changes, administrator access rights are required.



Settings on the DCOM interface may only be carried out by the EDP administrator because these settings may affect the user administration and networks can be damaged.

The first step could be to reduce the DCOM security in order to reduce the restrictions of the DCOM interface for all users. If the OPC communication will then be possible, it is reasonable to increase the security again step by step.

Described are the changes for Windows 2000 and Windows XP. Each of the screenshots on the left show the Windows 2000 user interface. Proceed as follows:

Windows 2000

1. Click on the "Start" button in the taskbar and click "Execute". The respective window will appear.
2. Enter "dcomcnfg" into the edit field and confirm with "OK". A window opens, click on "Default properties" here.

Windows XP

1. In the taskbar, click "Start", then click on "Execute" to open the respective window.
2. Type "dcomcnfg" into the edit field and confirm with "OK". The respective window opens, now click "Component Services", click "Computer", click "My Computer", and then right-click to open the context menu. In the context menu, click "My Computer Properties". There click on the "Default Properties" tab.

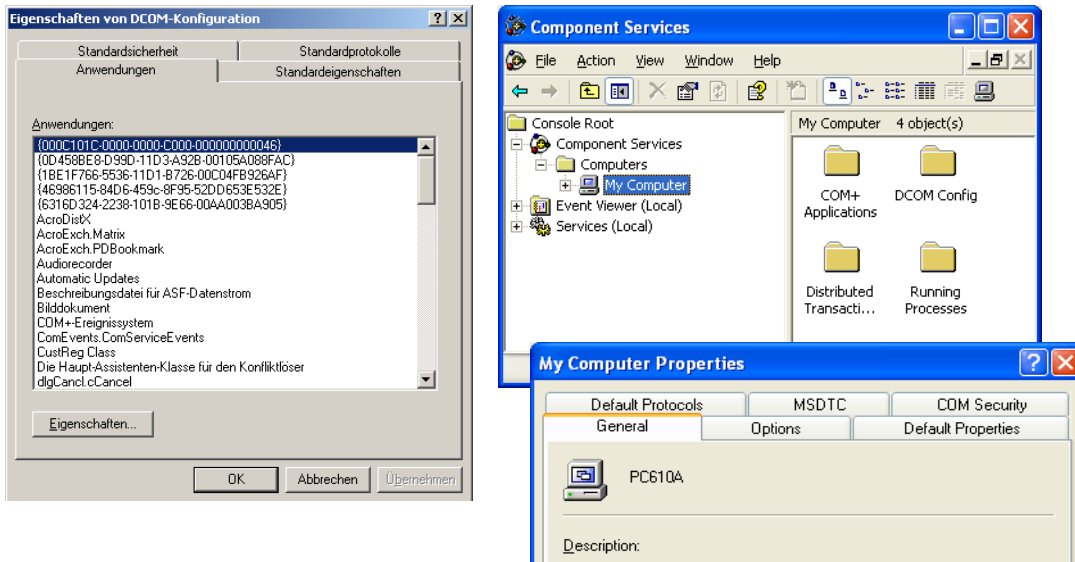

Fig. 8.1: Windows 2000

Windows XP

Windows 2000

3. In the "Default Properties" menu, select "(None)" from the "Default Authentication Level" field. Select "ANONYMOUS" from the "Default Impersonation Level" field. Confirm with "Apply".

Windows XP

3. In the "Default Properties" menu, select "(None)" from the "Default Authentication Level" field. Select "ANONYMOUS" from the "Default impersonation Level" field. Confirm with "Apply".

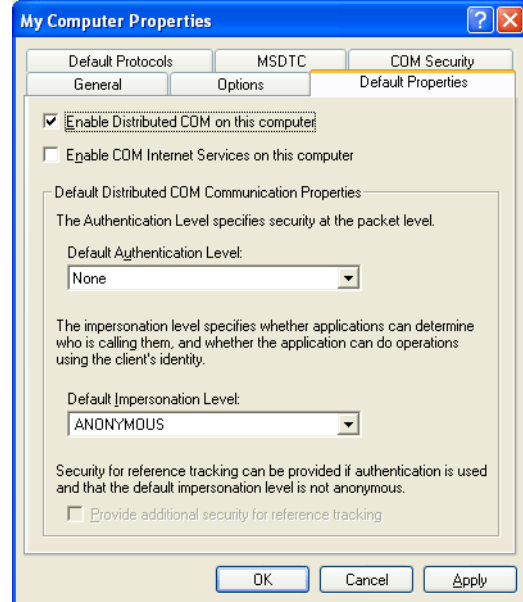
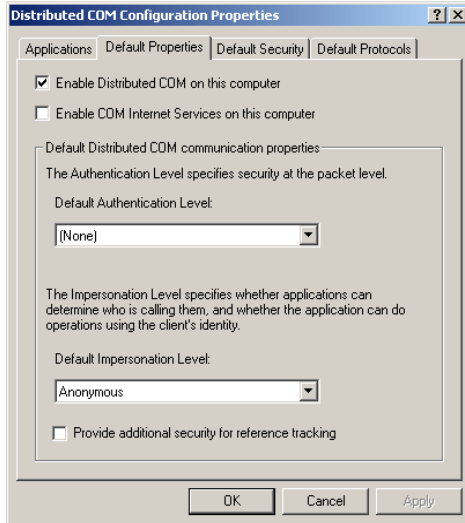

Fig. 8.2: Windows 2000

Windows XP

Windows 2000

4. Click on the "Default Security" tab. The respective window opens. In the "Default Access Permissions" menu, click "Edit Default".

Windows XP

4. Click the "COM Security" tab. The respective menu opens. In the "Access Permissions" menu, click "Edit Default".

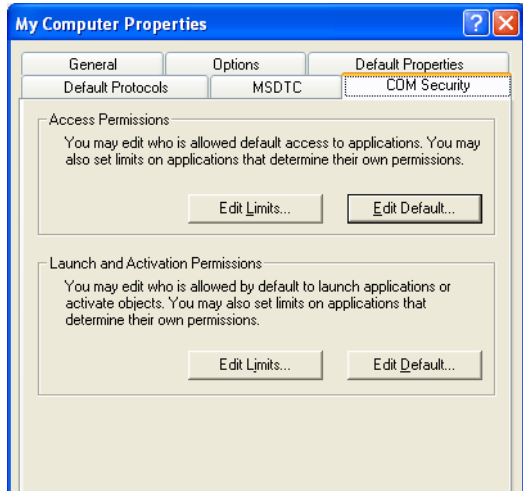
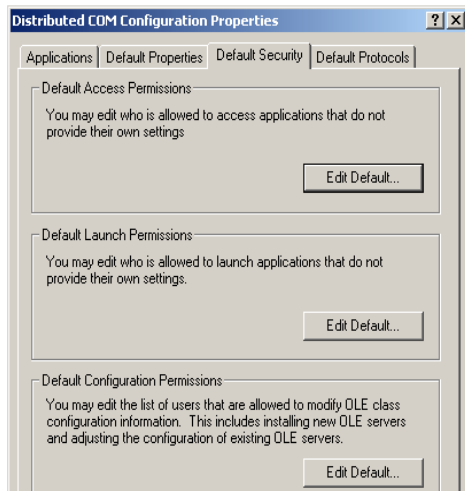

Fig. 8.3: Windows 2000

Windows XP

Windows 2000

- The "Registry value permissions" window will open.
Click "Add". The window "Select Users, Computers, or Groups" will appear. Select the user group "Everyone" and confirm with "Add". The selected user group will appear in the field at the bottom of the list. If "Allow Default Access Permission" does not appear, use the drop-down menu to select it. Confirm with OK.
Then you will return to the initial window, confirm once more with OK.

Windows XP

- The window "Access permission" "Default Security" appears.
Click "Add" unless the group name "Everyone" does not appear at the top of the list. The window "Select Users, Computers, or Groups" will appear. Type the user group "everyone" into the edit field and confirm with OK.
Activate the control box "Add" at the bottom of the window if it has not been activated yet. Confirm with OK.

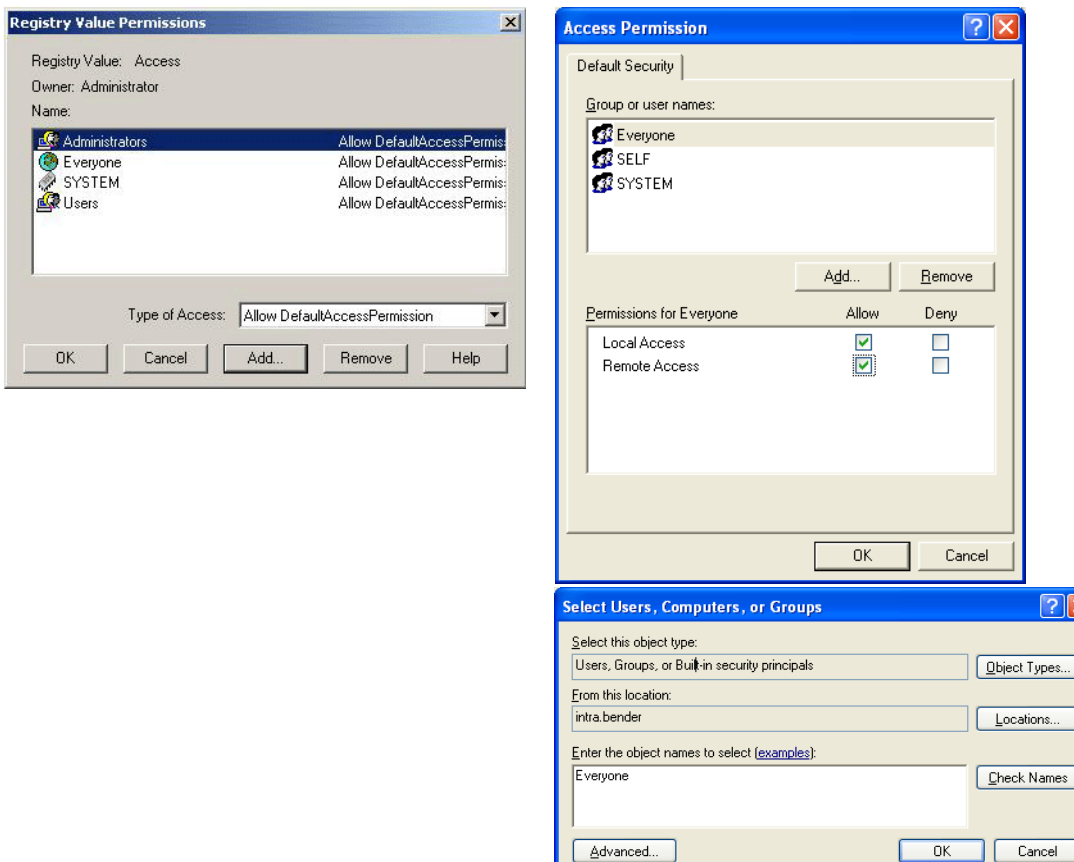

Fig. 8.4: Windows 2000

Windows XP

Once you returned to the "COM Security" menu, click "Edit Limits". The window "Access Permission" "Security Limits" will appear.

If the group name "Everyone" does not appear in the upper part of the list, click "Add". The window "Select Users, Computers, or Groups" will appear. Type the user group "Everyone" into the edit field and confirm with OK.

If the control box "Allow" in the lower part of the window has not been activated yet, activate it now and confirm with OK. Confirm with OK

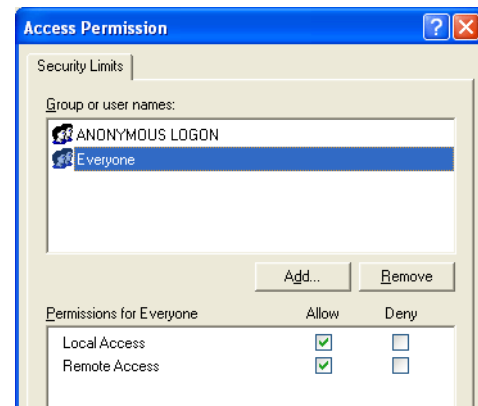

Fig. 8.5: ---

Windows XP

Windows 2000

- Now click the menu item "Default launch permissions" and click "Edit Default". The window "Registry Value Permissions" will appear.
Click "Add". The window "Select Users, Computers, or Groups" will appear. Select the user group "Everyone" and confirm with "Add". The selected user group will appear in the field in the lower part of the list. If "Allow Default Access Permission" does not appear, use the drop-down menu to select it. Confirm with OK.
Then you will return to the initial window, confirm once more with OK.

Windows XP

- Add to the launch and activation permissions the user group "Everyone" as well as "Edit Limits and "Edit Default".

When all the settings described above are completed, each user of the operating system has got full access to the DCOM interface and will be able to establish a connection between the OPC server and the OPC client.



Please note that the access security of the operating system is considerably reduced due to the settings made for testing purposes.

Summary:

The following modifications have been made due to the DCOM settings described in this chapter.

If you want to reset some DCOM settings, consider the values listed under "Settings OLD" or remove all user groups (Everyone) that have been added.

Windows 2000

Menu	Menu item	Setting OLD	Setting NEW
Default Properties	Default authentication level	Connect	(None)
	Default impersonation level	Identify	Anonymous
Default security	Default access permissions	-	Everyone/ allow access
	Default launch permissions	(previous entries)	Everyone/ allow launch (incl. previous entries)

Windows XP

Menu	Menu item	Sub item	Setting OLD	Setting NEW
Default properties	Default authentication level		Connect	None
	Default impersonation level		Identify	Anonymous
COM security	access permissions	Defaults	(previous entries)	Everyone/ allow access (incl. previous entries)
		Limits	Everyone/ allow access	(retain unchanged)
	Launch and activation permissions	Defaults	(previous entries)	Everyone/ allow launch (incl. previous entries)
		Limits	Everyone/ allow access	(retain unchanged)

8.3 Displaying BMS data using the OPC Demo Client

In this documentation, the Softing's OPC Demo Client is used to describe examples. You can find this Client under the following Internet address:
<http://www.softing.com>

Example:

A BMS system contains an FTC470XET with BMS address 1 and a residual current evaluator RCMS470-12 with BMS address 5. The BMS channels of the residual current evaluator (inputs) 2 and 4 are wired with measuring current transformers. The measured values are to be displayed on the OPC client. On the network side, the protocol converter FTC470XET should be accessible under the address 172.17.60.11.

8.3.1 Starting the OPC client and carrying out a connection to the OPC server

Please note that different views can be selected for the right frame of the client. Three different tabs are provided for selecting the appropriate view.

1. Start the client. Three menu items will appear. As indicated by the tab below the frame, this is the "OPC servers" view.
2. Click the plus sign next to "Manual" to go to the next lower level. An icon appears with a computer name or an address that can be edited.
3. Type the IP address of the FTC470XET into the edit field. The OPC server is also accessible under this IP address. Click the plus sign next to the address icon, the address will be applied and the next level will be displayed.
4. Click the plus sign next to "Data Access V2". Normally, the name of the accessed server will appear: "Bender OPC Server FTC470XET".

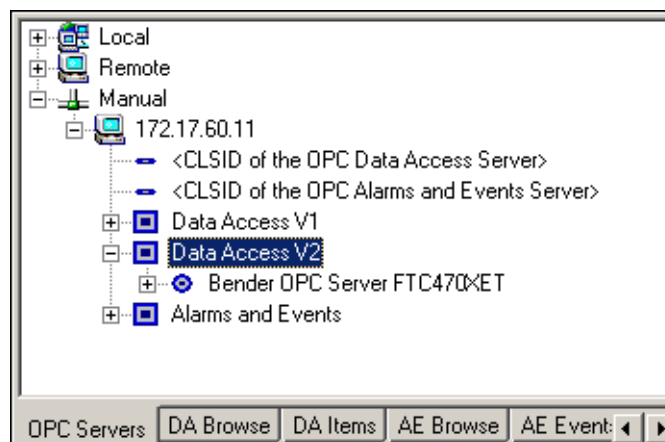

8.3.2 Data collection of the whole BMS system via BMS addresses and channels

1. Double-click the server icon or click the "Bender OPC Server" writing (under Data Access V2). A basic structure will appear in the frame on the left.
2. In the right frame click the "DA Browse" tab. The name of the OPC server and its IP address will appear on the highest level. Then click the plus sign next to it, the available addresses 5 and 1 in the BMS system will be displayed.
3. Click the plus sign next to BMS address 5, all channels of the respective device will appear. Then click on the plus signs of the channels 2 and 4. The OPC data structure (items) where the BMS measuring values are collected will appear. In this example, the items: value, type and alarm will be displayed.

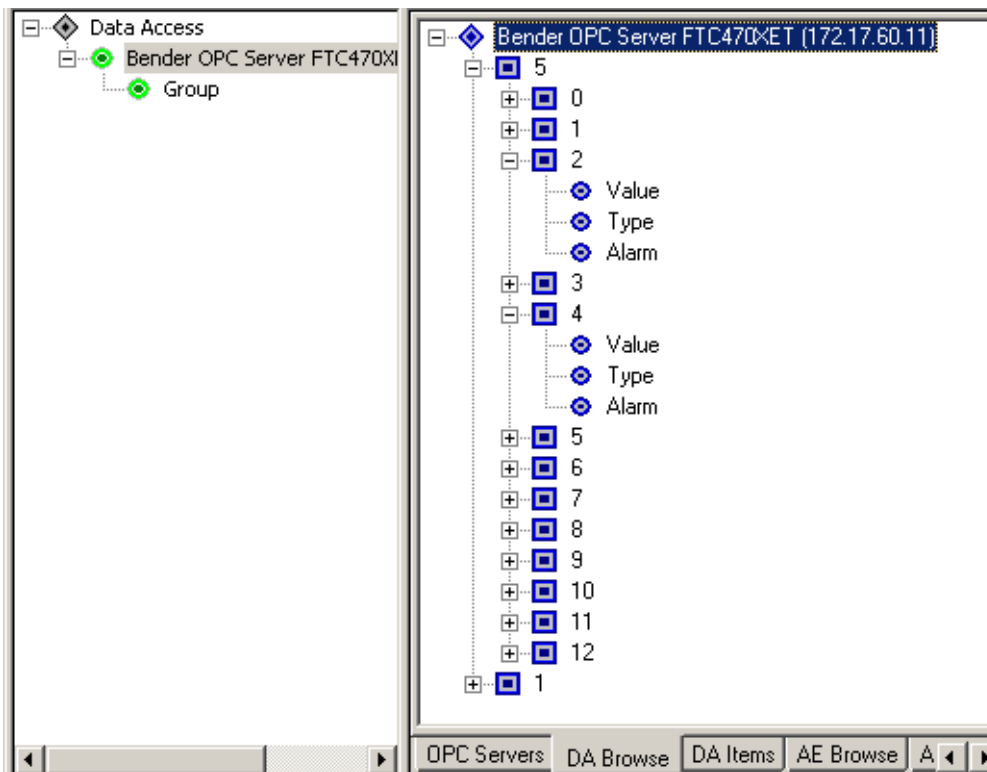

8.3.3 Compilation of the BMS addresses being monitored, BMS channels and items

A precondition is that the view "DA Browse" has been set.

1. Double-click all items of the BMS channels 2 and 4 in the right frame. The selected value, type and alarm items under their predefined group name will appear in the left frame.
2. Mark this group name and right-click to open the context menu. Select "Properties", the respective menu opens. Type the name of the device to be monitored into the edit field "Group Name": RCMS470-12. Confirm with OK.

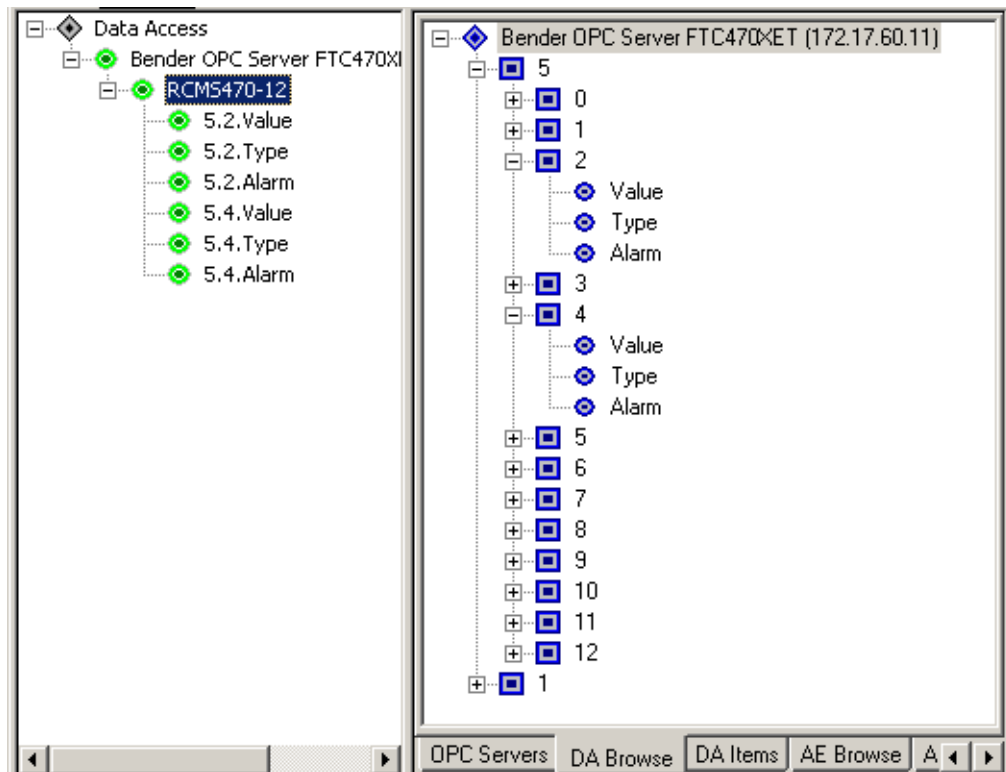

8.3.4 Monitoring of the compiled BMS addresses, BMS channels and items

1. Select "DA Items" using the respective tab.
2. The numerical values referring to the items already selected will be displayed in the column "Value".

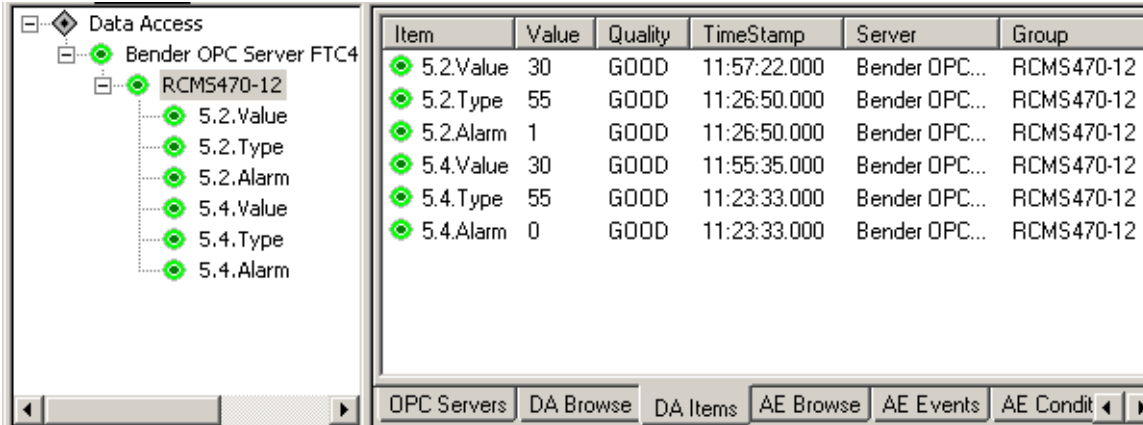

Item	Value	Quality	TimeStamp	Server	Group
5.2.Value	30	GOOD	11:57:22.000	Bender OPC...	RCMS470-12
5.2.Type	55	GOOD	11:26:50.000	Bender OPC...	RCMS470-12
5.2.Alarm	1	GOOD	11:26:50.000	Bender OPC...	RCMS470-12
5.4.Value	30	GOOD	11:55:35.000	Bender OPC...	RCMS470-12
5.4.Type	55	GOOD	11:23:33.000	Bender OPC...	RCMS470-12
5.4.Alarm	0	GOOD	11:23:33.000	Bender OPC...	RCMS470-12

Interpretation:

Value-Item = 30 ==> Numerical value 30 (BMS data value)

Type-Item = 55 ==> Residual current in mA (BMS data type)

Alarm-Item = 1 ==> Alarm message (BMS alarm)

The BMS device with address 5 provides an alarm message on channel 2:

The measured residual current has exceeded or has fallen below a predefined response value.

The second value triple shows the same residual current, but no alarm message. On channel 4, the measured residual current lies within the tolerances relating to a second response value (discriminator circuit).

The relationship between Type-Item and BMS data type

A "Type-Item" is the type of fault that initiated an alarm. It corresponds to the BMS data value and is listed in the table "alarm messages" on page 67.

- 3.

8.4 Channels, data types and data values of BMS devices

8.4.1 Alarm messages

Alarm messages develop when the response value of a device is exceeded or has fallen below a response value. Depending on the type of device these may be measuring values or statuses of a device. Alarm messages are provided by BMS devices and retrieved by the BMS master via the bus. Because of the safety-relevant significance, alarm values are given high priority on the bus.

Function	Device	BMS channel	BMS data type	BMS data value
Insulation faults in the IT system	107TD47	1	11	1
	IZ427	1		
	MK2418-11	1		
	SMI470-9	1		
Transformer overload	107TD47	2	11	2
	IZ427	2		
	MK2418-11	2		
	SMI470-9	2		
Transformer overtemperature	107TD47	3	11	3
	IZ427	3		
	MK2418-11	3		
	SMI470-9	3		
Failure Line 1	PRC487	1	11	4
	MK2418-11	4		
	SMI470-9	4		
Failure Line 2	PRC487	2	11	5
	MK2418-11	5		
	SMI470-9	5		
Insulation fault operating theatre lamp	107TD47	8	11	6
	MK2418-11	6		
	SMI470-9	6		
Failure voltage distribution board (Line 3, downstream the switchover and monitoring module)	PRC487	3	11	8
	MK2418-11	8		
	SMI470-9	8		
Failure N conductor	PRC487	4	11	29
Short circuit distribution board	PRC487	10	11	30
System connection fault	107TD47	4	12	101
	IRDH...	3		
PE connection fault	107TD47	5	12	102
	IRDH...	4		
	IZ427	5		
Short circuit CT input	107TD47	6	12	103
	EDS46x/49x	1...12		
	RCMS460/490	1...12		
CT connection fault	107TD47	7	12	104
	EDS46x/49x	7		
	RCMS460/490	7		
Fault K1 (open circuit, contactor cannot be switched on)	107TD47	7	12	104
	EDS46x/49x	7		
Fault K2 (open circuit, contactor cannot be switched on)	107TD47	7	12	104
	EDS46x/49x	7		
Fault K1 (open circuit, contactor cannot be switched on)	PRC487	5	12	107
	PRC487	5		
Fault K2 (open circuit, contactor cannot be switched on)	PRC487	6	12	108
	PRC487	6		

Function	Device	BMS channel	BMS data type	BMS data value
Control fault	MK2418-11 SMI470-9	7 7	12	112
Failure switching element K1 or Q1	PRC487	5	12	113
Failure switching element K2 or Q2	PRC487	6	12	114
Fault insulation monitoring device	107TD47 IRDH... IZ427	9 5 8	12	115
Changeover module in manual mode	PRC487	9	12	116
Open circuit closing coil K1	PRC487	5	12	117
Open circuit opening coil K1	PRC487	5	12	118
Open circuit closing coil K2	PRC487	6	12	119
Open circuit opening coil K2	PRC487	6	12	120
Switching element 1 cannot be switched on	PRC487	5	12	121
Switching element 1 cannot be switched off	PRC487	5	12	122
Switching element 2 cannot be switched on	PRC487	6	12	123
Switching element 2 cannot be switched off	PRC487	6	12	124
Failure contactor relay K3	PRC487	7	12	125
Fault Q1 (open circuit, load switch cannot be switched on)	PRC487	5	12	126
Fault Q2 (open circuit, load switch cannot be switched on)	PRC487	6	12	127
Fault PGH47..	PGH47..	5	12	136
Short circuit trip circuit breaker Line 1	PRC487	10	12	137
Short circuit trip circuit breaker Line 2	PRC487	10	12	138
Fault CV460	PRC487	8	12	139
Fault RK464	PRC487	8	12	140
Channel disabled	EDS...	1...12	21	0
Interferences (FAULT)	EDS..	1...12	31	0
Start-up of insulation fault location, runs until the input will be reset	PGH...	1	32	1
Start-up of insulation fault location for 1 pass (approx. 5 min.)	PGH...	2	33	1
Start/Stop insulation fault location via button	PGH...	4	34	1
Function of the device switched off (suppression)	PGH...	3	35	1
Start-up insulation fault location, continuous measuring without break	IRDH575	9	36	1
Start-up insulation fault location, position mode	IRDH575	9	36	Position
Undercurrent in mA	RCMS460/490	1...12	44	value
Undercurrent in A	RCMS460/490	1...12	45	value
Undercurrent < [value] in mA	RCMS460/490	1...12	46	value
Undercurrent < [value] mA	RCMS460/490	1...12	47	value
Insulation fault with fault current [value] in mA	EDS470/ 460/490	1...12	51	value
Insulation fault with fault current [value] in μ A	EDS473/ 461/491	1...12	52	value
Residual current > 10 A (FAULT)	EDS470/ 460/490	1...12	53	value
Residual current > 1 A (FAULT)	EDS473/ 461/491	1...12	53	value
Residual current < [value] in mA	EDS46x/49x	1...12	54	value
Residual current/overcurrent/undercurrent in mA	RCMS...	1...12	55	value

Function	Device	BMS channel	BMS data type	BMS data value
Residual current/overcurrent/undercurrent fault in A	RCMS...	1...12	56	value
Residual current/overcurrent/undercurrent fault > [value] in A	RCMS...	1...12	57	value
Prewarning residual current fault in mA	RCMS...	1...12	58	value
Prewarning residual current fault in A	RCMS...	1...12	59	value
Residual current < [value] in A	RCMS...	1...12	60	value
Insulation fault in k Ω	107TD47 IRDH...	1 1, 2	61	value
Insulation fault in Ω	107TD47 IRDH...	1 1, 2	62	value
Insulation fault in M Ω	107TD47 IRDH...	1 1, 2	63	value
Transformer load in %	107TD47 IZ427 MK2418-11 SMI470-9	2	65	value
Transformer load < [value] in %	IZ427	2	66	value
Transformer load < [value] in %	IZ427	2	67	value
Alarm digital input [value]	Mk2418C... TM... SMI471..	1... 8 1... 8 1... 8	70	value
Undervoltage in V	IZ427	4	75	value
Undervoltage < [value] in V	IZ427	4	76	value
Impedance in k Ω	IZ427	1	91	value
Impedance < [value] in k Ω	IZ427	1	92	value
Impedance > [value] in k Ω	IZ427	1	93	value
Prewarning impedance in k Ω	IZ427	1	94	value

8.4.2 Operating messages

Operating messages are information and/or measured values continuously provided by BMS devices and queried by the BMS master via the bus. Some BMS devices (EDS47x) do not provide operating messages, but only alarm messages.

Function	Device	BMS channel	BMS data type	BMS data value
Relay wired	SMO..	1...12	3	1
Line 1 ready for operation**	PRC487	1, 2	13	201
Line 2 ready for operation**	PRC487	1, 2	13	202
Switching element 1 is activated	PRC487	3	13	203
Switching element 2 is activated	PRC487	4	13	204
Changeover module in automatic mode	PRC487	5	13	206
Changeover module in manual mode	PRC487	6	13	207
Line AV ready for operation**	PRC487	1, 2	13	210
Line SV ready for operation**	PRC487	1, 2	13	211
Line UPS ready for operation**	PRC487	1, 2	13	212
Channel disabled	RCMS46x/49 EDS46x/49x	1...12	13	213
Channel disabled	RCMS470 EDS470	1...12	21	0
No CT connected. Input open	RCMS470	1...12	22	0
Input short-circuited	RCMS470	1...12	23	0
Undercurrent in mA	RCMS460/490	1...12	44	value
Undercurrent in A	RCMS460/490	1...12	45	value
Undercurrent < [value] in mA	RCMS460/490	1...12	46	value
Undercurrent > [value] in A	RCMS460/490	1...12	47	value
Residual current/overcurrent/undercurrent in mA	RCMS..	1...12	55	value
Residual current/overcurrent/undercurrent fault in A	RCMS..	1...12	56	value
Residual current/overcurrent/undercurrent fault > [value] in A	RCMS..	1...12	57	value
Insulation value in k Ω	107TD47 IRDH...	1 1, 2	61	value
Insulation value in Ω	107TD47 IRDH...	1 1, 2	62	value
Insulation value in M Ω	107TD47 IRDH...	1 1, 2	63	value
System leakage capacitance	IRDH...	3	64	value
Transformer load in %	107TD47 IZ427 MK2418-11 SMI470-9	2 2 1 1	65	value
Digital input set	SMI1471	1...4	70	value
Undervoltage in V	IZ427	4	75	value
Impedance in k Ω	IZ427	1	91	value
Impedance < [value] in k Ω	IZ427	1	92	value
Impedance > [value] in k Ω	IZ427	1	93	value

** Depending on the settings in the "Power" menu“.

9. How to use the FTP server

9.1 System software update

The FTC470XET protocol converter offers the possibility to update the device system software.

If necessary, please contact our technical sales office (Tel. +49 6401 807-0).

Copying the loaded software from your personal computer to the FTP-Server of the FTC470XET
For this purpose, the system administrator password is required!

1. Start the internal Web server of the protocol converter using the browser.
2. In the BMS Explorer, click the FTC submenu item "Software update". A short message of explanation appears and a button to start the FTP server.
3. Start the FTP server, it will be acknowledged. At the same time, the connection between the BMS bus and the Web server will be interrupted. In addition, two hyperlinks referring to different memory locations for the files to be updated will be displayed.
Note! The hyperlinks displayed are without function when the browser gets access to the FTC470XET via the Internet **and** is using the Internet connection NAT (Network Address Translation). In this case, contact your administrator.
4. Click the top hyperlink for files of the format *.dll, *.exe, *.lib, *.st, *.txt, amongst others, all files of this format used in the FTC470XET will appear.
5. Bring the Windows Explorer to the foreground and mark all files to be copied. Press "Strg" and "C" on the key pad in order to mark all files to be copied (to transfer the files to the clipboard). Return to the file window of the FTC470XET and press "Strg" and "V" in order to insert all files (overwrite mode).
6. Click the bottom hyperlink for files of the format *.htm, *.asp, *.inc, *.gif, amongst others, all files of this format used in the FTC470XET will appear.
7. Bring the Windows Explorer to the foreground and mark all files to be copied. Press "Strg" and "C" on the key pad in order to mark all files to be copied (to transfer the files to the clipboard). Return to the file window of the FTC470XET and press "Strg" and "V" in order to insert all files (overwrite mode).
8. Restart the FTC470XET after updating the files by pressing the reset button for approximately 4 s or by on/off switching of the supply voltage.

9.2 Backup of specific system files

Once the FTC470XET is configured according to the requirements, there is the possibility to save the currently created configuration files to a personal computer using the FTP server. A backup is recommended for the following files:

- DLsetup.txt
Settings for 20 existing data loggers.
- History.txt
Data of the history memory may be used for further evaluation.
- Param150.txt
System descriptions: user-defined description of locations and alarm text messages.
- ParamFTC.txt
User-defined parameters: such as e-mail recipients for alarm notifications. user-configured Internet/Intranet addresses (URLs).
- Table_SpracheAlarm.st
Table_SpracheSeite.st

Table_SpracheTyp.st

Language data files containing user-translated text.

Proceed as follows: (by way of example: there are different ways to carry out a copy process with Windows)

1. Create a target directory on the PC where the data backup is to be carried out.
2. In the BMS Explorer, click the FTC submenu item "Software update". A short message of explanation appears and a button to start the FTP server.
3. Start the FTP server, it will be acknowledged. At the same time, the connection between the BMS bus and the Web server will be interrupted. In addition, two FTP addresses (hyperlinks) appear referring to different memory locations for the files to be updated.
Note! The FTP addresses displayed are without function when the browser gets access to the FTC470XET via the Internet and is using the Internet connection NAT (Network Address Translation). In this case, contact your administrator.
4. Click the top FTP address to display the files of the formats *.dll, *.exe, *.lib, *.st, *.txt.
5. When the files to be loaded are represented as icons, mark the files using the mouse and the "Strg" key. Then right-click to open the context menu and select "Copy".
6. Now open the target directory and click "Insert" in the context menu. Normally, all the copied files should be stored in the directory now.

10. Service and support

10.1 Damage in transit

Damage in transit must be confirmed directly by the carrier. In case of doubt, please contact:
Dipl.-Ing. W. Bender GmbH & Co.KG
Londorfer Straße 65
35305 Grünberg
+49 6401 807-0

10.2 Malfunctions

If the FTC470XET causes malfunctions in the connected systems, please consult this operating manual.

10.2.1 What should be checked?

Check whether...

- the device is supplied with the correct supply voltage U_S ;
- the BMS bus cable is correctly connected and terminated (120 Ω);
- the appropriate Ethernet cable (RJ45) is correctly connected;
- the BMS address is correctly set;
- the start page of the FTC470XET Web server can be accessed by a Web browser;
- the network parameters are correctly set, at least the IP address and the net mask.

10.2.2 Where do you get help?

If, after thorough reading of the technical manual and intensive fault location in your installation, you cannot clear the fault caused by the protocol converter FTC470XET, please contact our technical sales office:

0049 (0)6401-807-0

or contact us via the Internet:

info@bender-de.com

10.3 Warranty claims

BENDER provides a guarantee for error-free design and perfect material quality lasting 24 months from date of delivery for the FTC470XET stored or operated under normal standard conditions.

This guarantee does not cover maintenance work of any kind and shall only be valid for the first purchaser. It shall not extend to products or individual parts thereof which have not been correctly used, or which have undergone modifications. Any warranty shall lapse if the device is used other than for the intended purpose.

The guarantee obligation is restricted to repairing or replacing equipment returned to BENDER within the guarantee period. In order for claims made under the terms of the guarantee to be accepted, BENDER must acknowledge that the product is faulty and that the fault concerned cannot be attributed to incorrect handling or modification of equipment, non-compliant use or abnormal operating conditions.

Any guarantee obligation will be rendered null and void if repairs or changes have been made to equipment by persons other than those authorised to do so by BENDER.

BENDER does not accept any liability for direct or indirect collateral or consequential damage regardless of whether this can be attributed to action considered permissible, impermissible or otherwise.

10.4 Warranty and liability

Warranty and liability claims in the event of injury to persons or damage to property are excluded if they can be attributed to one or more of the following causes:

- Use of the FTC470XET other than for the intended purpose.
- Improper installation, commissioning, operation and maintenance.
- Operation of equipment with faulty safety devices or safety and protective devices which have been fitted incorrectly or are not in perfect working order.
- Failure to comply with the information in the operating instructions regarding transport, storage, assembly or installation, commissioning, operation and maintenance.
- Constructional changes made by parties other than the manufacturer.
- Non-observance of technical data.
- Repairs carried out incorrectly and the use of replacement parts or accessories not approved by the manufacturer.
- Cases of disaster and force majeure.

11. Technical data

11.1 Data in tabular form

Insulation coordination acc. to IEC 60664-1

Rated insulation voltage.....	AC 250 V
Rated impulse voltage/pollution degree.....	4 kV/3

Voltage ranges

Supply voltage U_s (see nameplate)	AC/DC 85...276 V
.....	DC independent of polarity
Frequency range U_s	50...400 Hz
Power consumption	≤12 VA

Displays

Ethernet	2 LEDs: LINK (Ethernet connection set up), ACT (TCP/IP connection active)
BMS bus.....	2 LEDs: BMS, FAULT
Device/ Web server	1 Power ON LED:

Interfaces

Ethernet:

Interface/ protocol.....	RJ45 socket, Ethernet 10Base-T
Cable length.....	≤ 100 m
Recommended cable	screened network cable with RJ45 plug, STP, category 6
Baud rate	10 MBit/s, half duplex
IP addressing	setting per browser
IP address, factory setting	192.168.0.254
Net mask, factory setting	255.255.255.0

BMS bus:

Interface/ protocol.....	RS-485 (terminals A/B) / BMS protocol
Baud rate.....	9.6 kBit/s
Max. cable length	1200 m
Recommended cable (screened, screen on one side connected to PE)	J-Y(St)Y 2 x 0.6
Terminating resistor	terminal connection, 120 Ω (0.5 W)
Device address / factory setting	per DIP switch, 1...30 / 1

OPC via Ethernet:

OPC data access	v 2.0
ProgID	Bender.OPC.Server.FTC470XET.DA

System configuration

of the FTC Web server, of the BMS devices connected to the FTC:

Password, factory setting.....	ftc
--------------------------------	-----

General data

EMC immunity	EN 61000-6-2
EMC emissions	EN 61000-6-4
Shock resistance acc. to IEC 60068-2-27 (device in operation)	15 g/11 ms
Bumping IEC 60068-2-29 (during transport)	40 g/6 ms
Vibration resistance IEC 60068-2-6 (during operation)	1 g / 10...150 Hz
Vibration resistance IEC 60068-2-6 (during transport)	2 g / 10 ... 150 Hz
Ambient temperature, during operation.....	-10 °C...+55 °C
Storage temperature range -40 °C...+70 °C	
Climatic class acc. to DIN IEC 6072160721-3-3	3K5

Operating mode	continuous operation
Position	any position
Connection, BMS bus	screw terminals
Connection, rigid/flexible	0.2...4 mm ² / 0.2...2.5 mm ²
Connection flexible with connector sleeve, without/with plastic sleeve	0.25...2.5 mm ²
Conductor sizes (AWG)	24...12
Degree of protection, internal components (DIN EN 60529)	IP30
Degree of protection, terminals (DIN EN 60529)	IP20
Type of enclosure	X470, free from halogen
DIN rail mounting acc. to	IEC 60715
Flammability class	UL94 V-1
Software-Version	D176 V1.11
.....	D177 V2.2x
Weigth	approx. 350 g

11.2 Dimension diagram

The FTC470XET is incorporated in an enclosure of the 470 series, as illustrated below.

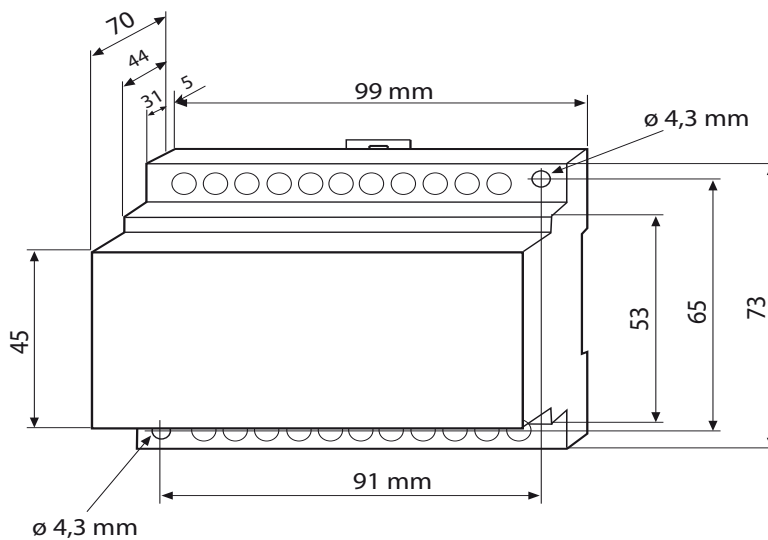

Possible is:

- DIN rail mounting acc. to IEC 60715 or
- Screw mounting

11.3 Ordering information

Type	Supply voltage U_s	Art. No.
FTC470XET (X470 enclosure, see dimension diagram)	AC 85...276 V / DC 85...276 V	B 9506 1001
FTC3000XET (in aluminium case, 270 x 205 x 115 mm, with connection cables)	AC 85...276 V	B 95061004
FTC185XET (in a plastic enclosure, 160 x 120 x 80 mm, with handle, with connection cables)	AC 85...276 V	B 95061003

12. Frequently asked questions:

- The FTC470XET cannot be accessed via the Web browser although the device has been connected properly and the IP address has been set correctly. What should be done?
Check whether the green LED "LINK" lights permanently. This signals an intact Ethernet connection. Send the command "Ping" to the device. If no packets get lost, the IP address is correctly set. Check whether the browser settings allow direct connection. An activated Proxy may prevent a connection to the Internet.
Check this setting in the Internet Explorer, via the path Extras/Internet Options/Connections/LAN settings, for example. Here, the automatic settings and the Proxy server can be deactivated. In the browser Firefox, for example, check whether the setting "direct connection to the Internet" is activated.
- Are all submenus represented as drop-down menus during the access to the FTC470XET Web server using the OPERA browser?
Answer:
OPERA and several other types or versions of browsers always represent the submenus as drop-down menus. That does not have an effect to the BMS Explorer function. The FTC Web site are optimised for the MS Internet Explorer.
- What should be done if only one frame instead of three frames is represented after entering the password for parameter setting?
Answer:
In such a case, click the update or repeat key of the browser currently in use in order to reload the screen page.
- On a screen page where measured values and other information are listed, erroneously zero, question marks or special characters appear at some places. What should be done?
Answer:
Probably there is a communication problem. It is recommended to repeat the request.
- The FTC470XET does not provide answers to the requests. The "ON" LED at the device lights up permanently. What should be done?
Answer:
The device does not operate properly, a hardware reset has to be carried out. Use a special tool to press the reset button R behind the front plate for approximately 4 s..
- An insulation fault evaluator EDS470-12 (EDS473-12, EDS474-12) connected to the BMS system is not indicated in the BMS explorer. What should be done?
Answer:
During insulation fault location it may happen that an EDS470-12 is not able to respond fast enough to the requests of the FTC470XET and is therefore not represented in the BMS Explorer display. In this case click "Update" in the BMS Explorer.
- TM panels (version 1.83 or higher) and a PRC1470 are installed in a BMS system for the local indication of messages. The panels cannot be parameterised with the FTC470XET.
What should be done?
It is not possible to parameterise the panels with the FTC470XET. You need the appropriate software for parameter setting.
- The FTC470XET provides the functions History and Data logger. What is the difference between these storage functions?
All alarm messages of the BMS system are automatically saved in the history memory that is continuously being activated.
The data loggers of the device have to be activated manually in order to record the measured values of the selected BMS channels (see page 35).

INDEX

A

- Activating e-mail or Intranet/Internet addresses 36
- Address setting
 - BMS 19
 - IP 21
- Alarm messages, OPC server 57, 67
- Alarms and prewarning highlighted in colours 32

B

- Backup of specific system files 71
- Basic configuration 19
- BMS address setting 19
- BMS device monitoring setting 39
- BMS explorer 28
- BMS settings 19
- Browser configuration 25

C

- Changing the password 31, 44
- Chapters at a glance 7
- Configuration of an alarm notification 42
- Connection
 - BMS 23
 - Ethernet 23
- Connection and mounting 23
- Current alarm messages, Web server 30, 34
- currently measured values 30

D

- damage in transit 73
- Data logger 30, 35
- Data logger setting 31, 38
- DCOM interface 58
- Default view 28
- Deleting entries 33
- Device information 30
- Device monitoring (BMS) setting 31, 39
- Device parameter setting 31

- Dimension diagram 76
- DIP switches, BMS addresses 15
- Display and operating elements 14

E

- E-mail parameter setting 31
- E-mail parameter setting for notification in case of alarm 42
- Entering system description 31
- Entering URL for Links 31
- Example
 - Calculating measuring values 46
 - Changing an alarm text or a measuring point description 52
 - CT connection monitoring parameter setting 49
 - Disabling a measuring input 48
 - Discriminator circuit with RCMS470-12 51
 - Monitoring an N conductor for undercurrent 49
 - Retrieving device information 46
 - Setting a CT correction factor 50

F

- Factory setting, BMS address 19
- Factory setting, IP address 22
- FAQs 79
- Frequently asked questions 79
- FTC470XET features 13
- FTC470XET is not accessible 79
- FTP server 71

H

- History memory 30, 35
- History memory setting 31
- How to use this manual 7

I

- Indication of alarms and colours 32
- Input devices 33
- Installation 19
- IP address
 - setting 21
- IRDH275B monitoring 53
- IRDH275B parameter setting 54

L

- Language selection for the user interface 34
- Liability 74

M

- Malfunctions 73
- Menu items 30
- Minimal system 11
- monitoring and parameterization frame 32
- Mounting and connection 23

N

- Network parameter setting 31, 41
- Network parameters reset to factory setting 22
- Normal use 17

O

- OPC client
 - Carrying out a connection to the OPC server 63
 - Monitoring of the compiled BMS devices 66
 - Starting the client 63
- OPC compatibility with the operating system 58
- OPC compatibility with Windows 2000 58
- OPC compatibility with Windows XP 58
- OPC Demo Client 63

OPC server 57
Operating messages, OPC server 70
Ordering information 77

P

Parameter setting of an RCMS470-12 48
Password for parameter setting 34
Password protection 28
POP3 authentication before SMTP authentication 42

Q

quick reference guide 8

R

RCMS470-12 monitoring 45
Redundant master function 16
RESET pushbutton R 15
Reset to default view 28
Resetting the IP address
- to factory setting 22

S

Sending a test mail 31, 44
SMTP authentication 42
Software update 31
Standard application 12
Start page 34
Start page 30
Submenu items 30, 31
Submenus for the system administrator 31
Summertime changeover 37
Support 73
System description 30
System logger 30
System logger setting 31
System overview 30, 34
System software update 71

T

Table alarm messages 67
Table operating messages 70
TCP/IP settings 21
Translation 31
Translation of previously used terms into any target language 39

U

User interface of the internal Web server 25
User interface structure 27

V

View for the BMS administrator 28
View for the system administrator 28

W

Warranty 74
Warranty claims 73
Web browser 25
Wiring diagram FTC470XET 24
Work activities on electrical installations 9



D611001800

Dipl.-Ing. W. Bender GmbH & Co. KG

Londorfer Str. 65 • 35305 Grünberg • Germany
Postfach 1161 • 35301 Grünberg • Germany

Tel.: +49 6401 807-0

Fax: +49 6401 807-259

E-Mail: info@bender-de.com

Web server: <http://www.bender-de.com>

